

## **Appendix A**

Luminaire Schedule

Luminaire Cutsheets

Lamp Cutsheets

Ballast Cutsheets

## Luminaire Schedule

Luminaire Type	Manufacturer	Catalog #	Lamps	Ballast Type	Volts	Comments
A	Se'lux	M1B1-2T5-SA-X SH-004-WH-277- DM	(2) FP28/835 (L1)	M1	120	Recessed slot downlight, Dimming Ballast
B	Lighting Services Inc	C100-00-W	50PAR20-H- SP10 (L2)	n/a	120	Track Lighting Mounted to Skylight Opening
C	Se'lux	M1B1-1T5-SA-X SH-004-WH-277	(1)-FP28/835 (L1)	M2	277	Recessed Continuous slot downlight
D	Se'lux	M1N1-TS	(1)-FP28/835 (L1)	M2	277	Recessed continuous sconce with satin diffuse lens
E	Kurt Versen	H8632-WT	(1)-PLT/32W/ 835/ 4P/ ALTO (L3)	M3	277	Recessed 6" Square Downlight
F	Lightolier	CL-1-4-E82	(1)- F032/835/ECO (L4)	M4	277	Stairwell cove fixture. See Proceeding information on mounting details.
G	Bega	8996MH	(1)CDM100/ 830/ED17 (L5)	M5	277	Pole area walkway lighting
H	Erco	34105.023	(1)MC39T6/ U/G12/ 835PB (L6)	M6	277	Banner Floodlight
I	Bega	1323	(1)20T3Q/ MINISTAR/S (L7)	-	12v	Step light with integral transformer. Supply 120v to fixture.
J	Light Wild	LW/Tile/FLR/ RECT/ 2.165x11.8/ FROST/RGB/ BOXY	72 LEDs (6W)	-	24V DC	In-grade fixture, integral transformer, supply 120v AC.
K	Focal Point	FTV/14/D/ 2/T5/E/277/ G/PB/DF/BK	(2) FP28/835 (L1)	M1	120	Recessed 1'x4' troffer, black matte finish louvers. Dimmable Ballast. To be mounted flush with bottom of channel.
L	Lighting Services Inc.	C100-00-B	(1)50PAR20/ H/FL25 (L8)	n/a	120	Recessed Track mounted at top of channel. Black finish housing. 25 degree beam spread.
M	Lighting Services Inc.	C100-00-B	(1)50PAR20/ H/SP10 (L2)	n/a	120	Recessed Track mounted at top of channel. Black finish housing 10 degree beam spread.
N	Lighting Services Inc.	C110-00-B	(1)50PAR30/ HIR/FL35 (L9)	n/a	120	Recessed Track mounted at top of channel. Black finish housing 35 degree beam spread.
O	Color Kinetics	#116/ 000016/ 00/00	144LEDs (280W)	-	120V	Custom in grade housing to accommodate pedestrian traffic load.
P	Prescolite	D4LED/277V/ 4D9/WT	4 LEDS (13W)	-	277V	Surface Mounted Canopy Downlight,

# M100 Super Recessed Linear Fluorescent Flanged Extrusion



<b>Project:</b>							<b>Type:</b> A	<b>Qty:</b>
M1B1 -	2T5 -	SA -	x -	SH -	004 -	WH -	277	
<b>Fixture Series</b>	<b>Lamp Type</b>	<b>Upper Shielding</b>	<b>Lower Shielding</b>	<b>Mounting</b>	<b>Nominal Length</b>	<b>Finish</b>	<b>Voltage</b>	
DM -	-	-	-	-	-	-	-	

Options (refer to separate data sheets for ordering codes and details)

Fixture Series	Lamp Type	Upper / Lower Shielding	Mounting	Nominal Length	Finish	Voltage	Options
<b>M1B1</b> M100 Super Recessed Continuous Flange (Flanged Extrusion/ Flanged Endcaps)	1T5 F28T5 2T5 (2c)F28/T5 1T5HO F54T5HO	<b>SA</b> Specular Parabolic <b>MA</b> Matte Parabolic <b>MP</b> Silky Specular Parabolic <b>PL</b> Matte Perforated Parabolic <b>SD</b> Satine Lens <b>OD</b> Extra Diffuse Lens <b>X</b> None	<b>SH</b> Suspension Clips <b>TS</b> 1" Studs (factory installed) <b>RC</b> Rotating Crossbars <b>PM</b> Perimeter Mount	004 4 foot 008 8 foot 012 12 foot  For actual lengths see following page. For other lengths, configurations indicate nominal length rounded to the next highest foot. Factory will supply layout drawings. Individual fixtures cannot be field joined.	<b>WH</b> White <b>BK</b> Black <b>SV</b> Silver <b>SP</b> Specify RAL#	120 277 347	<b>TB</b> Lengths to Fit 2' Grid T-Bar Ceiling System <sup>1</sup> <b>(*)EM</b> Stand-by Battery Pack <sup>2</sup> (prefix quantity, i.e. - 5EM) <b>FS</b> Single Fusing <b>DM</b> Dimming <sup>3</sup> (specify system) <b>DMA</b> Digital Addressable Dimming <sup>3</sup> <b>SI</b> Satine Acrylic Inlay <sup>4</sup> <b>FW</b> Flex Whip (standard) <b>FW1</b> Flex Whip (dimming) <b>Track</b> Eutrac Standard <sup>5</sup> <b>DL</b> Suitable for Damp Locations <b>CCEA</b> Chicago Plenum <b>Downlights</b> (See MR16 spec sheets, pp.98-99)

<sup>1</sup>M1B1 w/ T5 & T5HO lamps only, consult factory for other lamps. <sup>2</sup>Must be low profile ballasts (1 1/2" W x 1 1/4" H); consult factory for details. <sup>3</sup>Consult factory for details. <sup>4</sup>SA, MA, MP & PL shieldings only.

## Mounting Diagrams

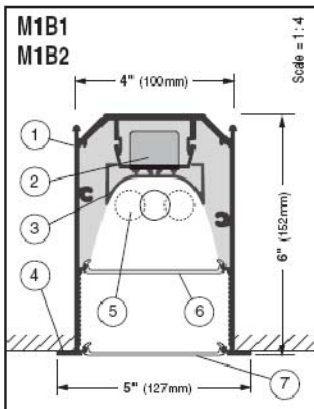
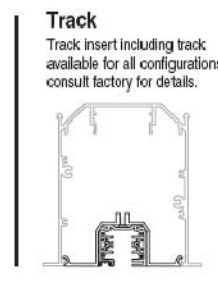
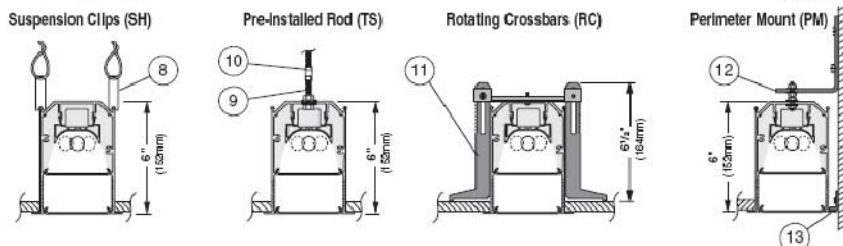

- Housing** - Continuous, 6063-T5 extruded aluminum profile up to 16 feet long. Joined with Connector Plus Joining System for ease of installation and to assure a uniform appearance.
- Ballast** - Electronic, high power factor, class "P", type "A" sound rating. Specify 120v, 277v, or 347v. Ballast is factory pre-wired with leads to one end of fixture. Consult factory for ballast options.
- Gear Tray** - Extruded aluminum, with white painted finish. Gear tray installed as a complete electrical unit and is held in place with knurled dress nuts. It is fully accessible from below ceiling.
- Flange** - 1/2" (12mm) wide flange runs full lengths of both sides and is part of the main extruded body. Specify continuous flange (M1B1) or flush end (M1B2).

- Lamps** - As noted (by others). Other lamp lengths or wattages available, consult factory.
- Upper Shielding** - Louvers offer excellent glare control in longitudinal, lateral, and all diagonal planes. High quality aluminum louvers and acrylic shielding allow true freedom of layout for today's modern spaces.
- Lower Shielding** - Same options as Upper Shielding #6.
- Spring Steel Suspension Clips** - Supplied two places, located nominally every 4 ft. Support wires supplied and installed by others.
- Pre-installed 1" 1/4-20 Stud** - Attached to fixture every nominal 4 feet.
- Coupling and Threaded Rod to Structure** - Supplied and installed by others.

- Rotating Crossbar** - For inaccessible ceilings, adjustable for ceiling thicknesses from 1/4" to 2". Support required nominally every 4 feet.
- Steel Wall Bracket and 1/4-20 Rod** - Supplied nominally every 4 ft. (Fasteners to wall and wall anchors by others)
- Aluminum wallbracket** - Secured to wall (fasteners and wall anchors by others) and runs entire length of fixture. Also supplied for width of fixtures when supplied with continuous flange. Allows for 1/8" gap between flange and wall to create shadow line allowing for unevenness of wall.
- Interior Luminaire Finish** - Standard interior colors are White (WH), Black (BK) and Silver (SV). RAL colors (SP) are available, please specify RAL#.

SELUX Corp. © 2006  
TEL: (845) 691-7723  
FAX: (845) 691-6749  
www.selux.com/usa  
M1B1-01 (v5.0)



In a continuing effort to offer the best product possible, we reserve the right to change, without notice, specifications or materials that in our opinion will not alter the function of the product. Specification sheets found at www.selux.com/usa are the most recent versions and supercede all other printed or electronic versions.

# M100 Super Recessed Linear Fluorescent Flanged Extrusion



## M1B1 and M1B2 Layout Dimensions

Specify T5 lamps when using in grid ceiling systems where 24" or 48" light openings are required.

M1B1 Recessed - nominal 4 foot individual



M1B1 Recessed - T-Bar Length - nominal 4 foot individual

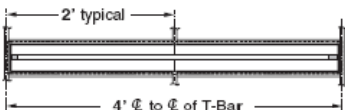

M1B1 Recessed - nominal 8 foot individual



M1B1 Recessed - T-Bar Length - nominal 8 foot individual

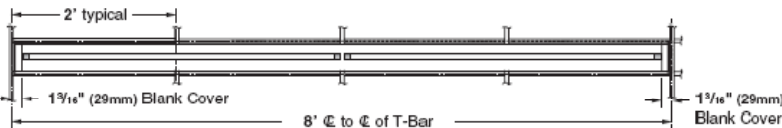

M1B1 Recessed - nominal 12 foot individual



M1B1 Recessed - T-Bar Length - nominal 12 foot individual



Typical Side View

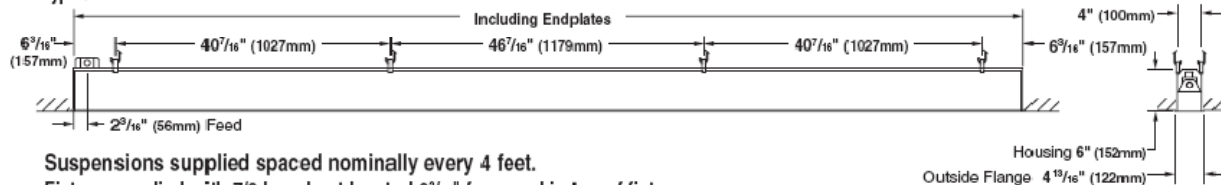

Suspensions supplied spaced nominally every 4 feet.

Fixture supplied with 7/8 knockout located 2 3/16" from end in top of fixture.

Continuous Flange (M1x1)



(M1R1 Shown)

Flush End (M1x2)



(M1R2 Shown)

	T5 (1 or 2 lamp)				T8 (1 lamp)	
	M1B1/M1B2 Including Endplates	M1B1 Outside Flange	M1B1/M1B2 - TB Including End plates	M1B1 - TB Outside Flange	M1B1/M1B2 Including Endplates	M1B1 Outside Flange
4 foot individual	46.81" (1186mm)	47.58" (1209mm)	47.03" (1195mm)	47.91" (1216mm)	48.33" (1228mm)	49.20" (1250mm)
8 foot individual	93.21" (2365mm)	94.00" (2388mm)	95.03" (2414mm)	95.91" (2436mm)	96.37" (2448mm)	97.24" (2470mm)
12 foot individual	139.65" (3544mm)	140.41" (3567mm)	143.03" (3633mm)	143.91" (3655mm)	144.41" (3668mm)	145.28" (3690mm)

For other lengths, lamping, continuous runs or configurations please specify overall length (in feet), accessories desired and sketch/drawing of configuration. SELUX will detail project drawings upon order and supply submittal drawings for approval. Individual fixtures cannot be field joined. If you have any questions please contact SELUX customer service or applications engineering for assistance (1-800-SELUX-CS).

SELUX Corp. © 2006  
PO Box 1060, 5 Lumen Lane / Highland, NY 12528  
TEL: (845) 691-7723 / FAX: (845) 691-6749  
E-mail: seluxus@selux.com / Web Site: www.selux.com/usa  
M1B1-02 (02/06)

In a continuing effort to offer the best product possible, we reserve the right to change, without notice, specifications or materials that in our opinion will not alter the function of the product. Specification sheets found at www.selux.com/usa are the most recent versions and supersede all other printed or electronic versions.

Job Name:

Type:

Order Number:

## C100 Series 120V PAR16/20



C100-00

The C100 Cylinder is a fully adjustable specification grade fixture that aesthetically conforms to most architectural spaces. It can be utilized for either accent or general lighting dependent upon the wattage and beam spread of the PAR16 or PAR20 medium screw base lamp used. Its clean appearance makes it perfect for interior spaces such as museums, galleries, exhibits, boutiques, residences and similar areas where short and medium throw applications are needed.

Optional A size accessories include: Louver, Glass Color Filters and Spread Lens, Glass UV Blocking Filter and Stainless Steel Light Blocking Screens. Integral Dimmer and Coiled Cord are also available.

Features include self-locking adjustable full steel yoke for focusing in all planes, on/off safety switch for relamping and maintenance, and multiple accessory clips that will hold a combination of any LSI accessories.

Units will also accept all of the energy conserving Halogen lamps up to 75 watts.

UL and CUL Listed  
 USA Manufactured / IBEW

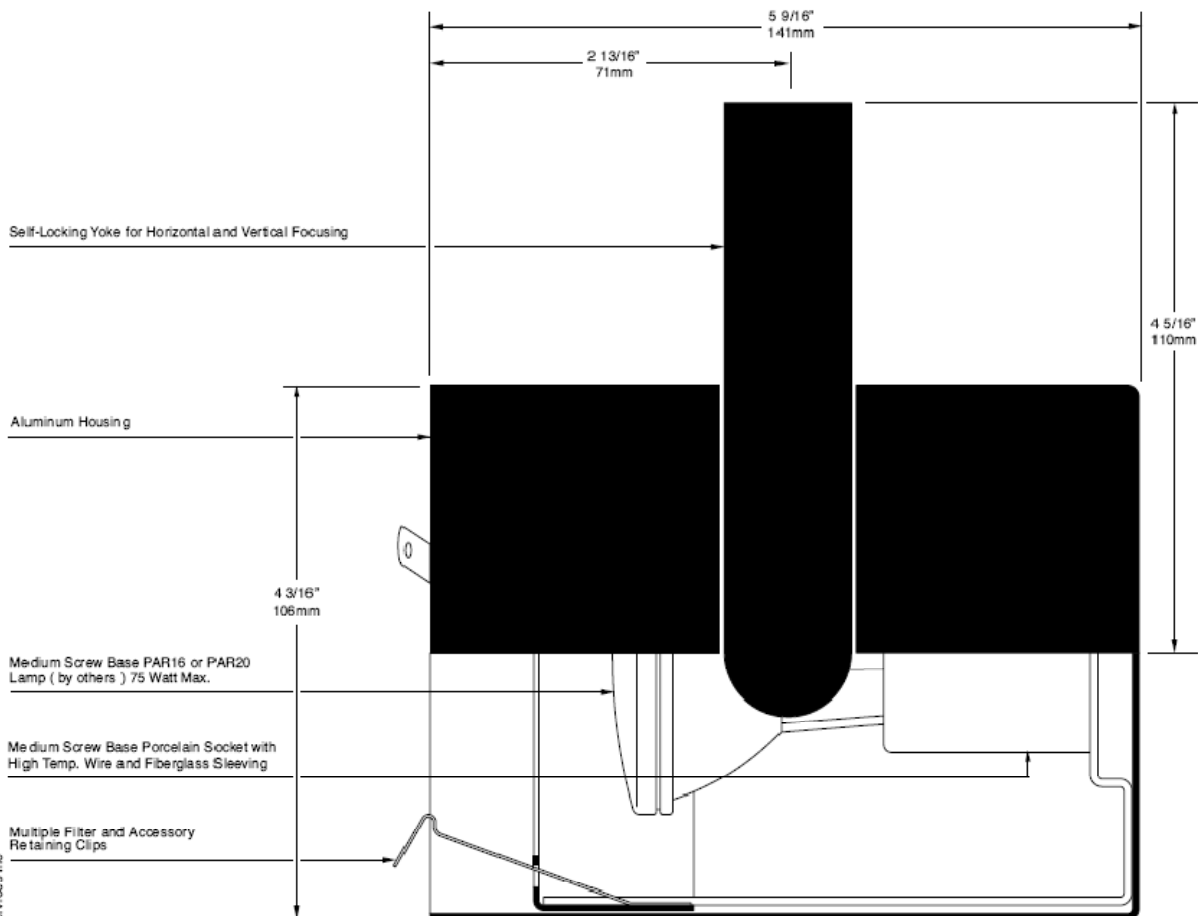

© 1996 Lighting Services Inc

Job Name:

Type:

Order Number:

# C100 Series 120V PAR16/20

## Photometric Data<sup>6</sup>

**50PAR20/H/SP10°** 50 watt, Narrow Spot  
Beam Spread to 50% of CBCP 10°  
Center Beam Candlepower 6000

**50PAR20/H/FL25°** 50 watt, Narrow Flood  
Beam Spread to 50% of CBCP 25°  
Center Beam Candlepower 1500

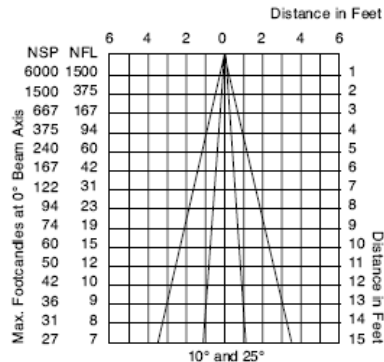

**75PAR16/CAP/NSP/10** 75 watt, Narrow Spot  
Beam Spread to 50% of CBCP 10°  
Center Beam Candlepower 7500

**75PAR16/CAP/NFL/30** 75 watt, Narrow Flood  
Beam Spread to 50% of CBCP 30°  
Center Beam Candlepower 1900

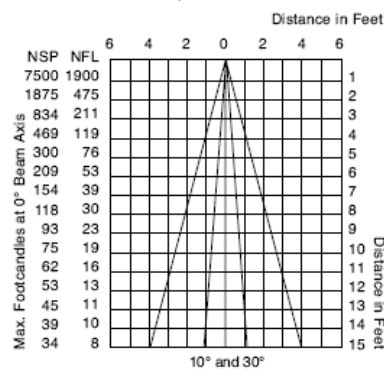

## Lamp Types

**35PAR20/CAP/NSP** 35 watt, 2500 hours  
Beam Spread to 50% of CBCP 8°  
Center Beam Candlepower 3000  
Color Temperature 2800K

**35PAR20/CAP/NFL** 35 watt, 2500 hours  
Beam Spread to 50% of CBCP 30°  
Center Beam Candlepower 900  
Color Temperature 2800K

**35PAR20/CAP/WFL** 35 watt, 2500 hours  
Beam Spread to 50% of CBCP 40°  
Center Beam Candlepower 600  
Color Temperature 2800K

**50PAR20/H/SP10°** 50 watt, 2500 hours  
Beam Spread to 50% of CBCP 10°  
Center Beam Candlepower 6000  
Color Temperature 2800K

**50PAR20/H/FL25°** 50 watt, 2000 hours  
Beam Spread to 50% of CBCP 25°  
Center Beam Candlepower 1500  
Color Temperature 2800K

**75PAR16/CAP/NSP** 75 watt, 2000 hours  
Beam Spread to 50% of CBCP 10°  
Center Beam Candlepower 7500  
Color Temperature 3000K

**75PAR16/CAP/NFL** 75 watt, 2000 hours  
Beam Spread to 50% of CBCP 30°  
Center Beam Candlepower 1900  
Color Temperature 3000K

## Accessories

- Louwer A**  
1/2" cellular metal louwer, controls spill light and glare, 45° cutoff.
- Glass Color Filters, Size A**  
Selection of 95 permanent rimmed dichroic, and rimmed and slotted standard colors.
- Spread Lens A990**  
Permanent glass lens for spreading light beam in one axis—nominal 5°X 50°.
- Spread Lens A992**  
Permanent molded glass lens for spreading light beam in one axis—nominal 5°X 30°.
- Spread Lens A995**  
Permanent molded glass lens for spreading light beam in all directions—nominal 50°X 50°.
- Spread Lens A996**  
Permanent molded glass lens for spreading light beam in one direction slightly more than the other—nominal 45°X 50°.
- Beam Softener A998**  
Permanent glass lens for conditioning light to create a softer beam.

**OPTIVEX™ UV Blocking Filter A962**  
Eliminates ultra-violet wavelengths below 410±10nm. Especially useful for conservation of artworks and to help prevent fading.

**Light Blocking Screens, Size A**  
A801S-20% Light Blocking, A802S-30% Light Blocking, A803S-40% Light Blocking Stainless Steel Screens. Used individually or in combination to reduce transmitted light without changing its color temperature.

**Coiled Cord**  
18/3 105°C, 18" retracted, 6 foot extended. Specify by adding suffix CC to model number. White fixture supplied with white cord, all other finishes supplied with black cord.

**Wrench Locking**  
For permanent locking of fixture position, add "WL" to model number.

**Integral Dimmer**  
For Yoke Mounted Dimmer add Suffix "FD" to model number.



## Ordering Information Model Number

add suffix letters for finish

**C100-00**  
Lexan Fitting for 1 and 2 circuit LSI Track. With switch.

**C100-00F**  
Same as above, with fuse.

**C100-2G**  
Universal fitting for Unistrut Systems and any screw or bolt-up applications. With switch, 6-foot 3-wire grounding cord and plug.

**C100-3G**  
C-clamp for pipes from 5/8" to 2" O.D. With switch, 6-foot 3-wire grounding cord and plug.

**\*C100-4G**  
Cushioned weighted base for floor or table use. With switch, 6-foot 3-wire grounding cord and plug.

**C100-5A**  
Canopy for permanent mounting on standard 4" octagonal outlet boxes

**Finishes (Paint)**  
Black (suffix B)  
White (suffix W)  
Silver (suffix S)  
Graphite (suffix G)  
Platinum (suffix P)

Notes:  
1. CBCP = Center Beam Candlepower  
2. K = Color Temperature in Kelvin degrees  
3. H = Halogen  
4. CAP = Capsyite  
5. OPTIVEX™ glass is a trademark of Bausch & Lomb Inc  
6. Lamp manufacturers published data  
\*Non-UL and Non-CUL

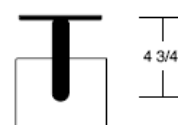
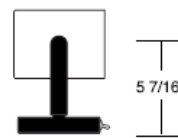
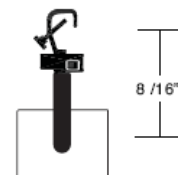
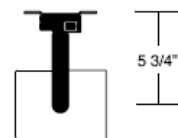
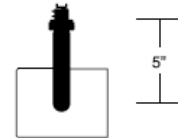



# M100 Super Recessed Linear Fluorescent Flanged Extrusion



Project: \_\_\_\_\_ Type: **C** Qty: \_\_\_\_\_

M1B1	-	1T5	-	SA	-	X	-	SH	-	004	-	WH	-	277
Fixture Series		Lamp Type		Upper Shielding		Lower Shielding		Mounting		Nominal Length		Finish		Voltage

Options (refer to separate data sheets for ordering codes and details)

Fixture Series	Lamp Type	Upper / Lower Shielding	Mounting	Nominal Length	Finish	Voltage	Options
M1B1 M100 Super Recessed Continuous Flange (Flanged Extrusion/ Flanged Endcaps)	1T5 F28T5	SA Specular Parabolic	SH Suspension Clips	004 4 foot	WH White	120	TB Lengths to Fit 2' Grid T-Bar Ceiling System <sup>1</sup>
	2T5 (2x)F28T5	MA Matte Parabolic	TS 1" Studs (factory installed)	008 8 foot	BK Black	277	(qty)EM Stand-by Battery Pack <sup>2</sup> (prefix quantity, i.e. -5EM)
	1T5HO F54T5HO	MP Silky Specular Parabolic	RC Rotating Crossbars	012 12 foot	SV Silver	347	FS Single Fusing
	1T8 F032T8	PL Matte Perforated Parabolic	PM Perimeter Mount	For actual lengths see following page. For other lengths, configura- tions indicate nominal length rounded to the next highest foot. Factory will supply layout draw- ings. Individual fixtures cannot be field joined.	SP Specify RAL#		DM Dimming <sup>3</sup> (specify system) DMA Digital Addressable Dimming <sup>3</sup> SI Satline Acrylic Inlay <sup>4</sup> FW Flex Whip (standard) FW1 Flex Whip (dimming) Track Eutrac Standard <sup>5</sup>
M1B2 M100 Super Recessed Flush End (Flanged Extrusion/ Flangeless Endcaps)		SD Satline Lens OD Extra Diffuse Lens X None					DL Suitable for Damp Locations CCEA Chicago Plenum Downlights (See MR16 spec sheets, pp.98-99)

<sup>1</sup>M1B1 w/ T5 & T8-HO lamps only, consult factory for other lamps. <sup>2</sup>Must be low profile batteries (1 7/8" Wx 1 1/2" H); consult factory for details. <sup>3</sup>Consult factory for details. <sup>4</sup>SA, MA, MP & PL shieldings only.

## Mounting Diagrams

Suspension Clips (SH)

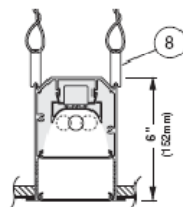

Pre-installed Rod (TS)

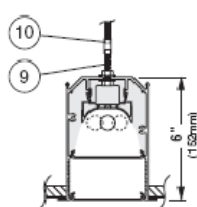

Rotating Crossbars (RC)

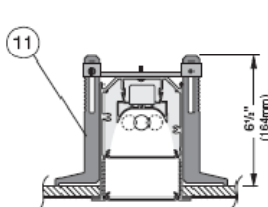

Perimeter Mount (PM)

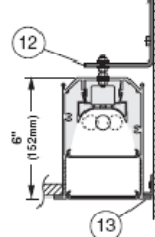

Scale = 1 : 8

## Track

Track insert including track available for all configurations, consult factory for details.

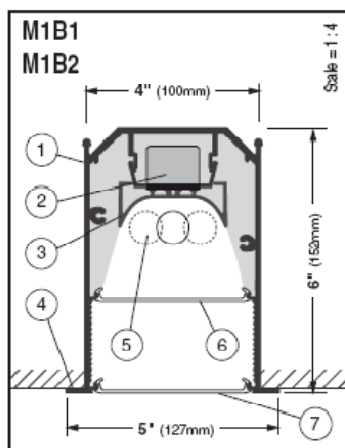
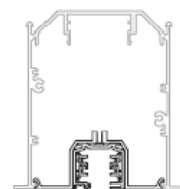

1. **Housing** - Continuous, 6063-T5 extruded aluminum profile up to 16 feet long. Joined with Connector Plus Joining System for ease of installation and to assure a uniform appearance.

2. **Ballast** - Electronic, high power factor, class "P", type "A" sound rating. Specify 120v, 277v, or 347v. Ballast is factory pre-wired with leads to one end of fixture. Consult factory for ballast options.

3. **Gear Tray** - Extruded aluminum, with white painted finish. Gear tray installed as a complete electrical unit and is held in place with knurled dress nuts. It is fully accessible from below ceiling.

4. **Flange** - 1/2" (12mm) wide flange runs full lengths of both sides and is part of the main extruded body. Specify continuous flange (M1B1) or flush end (M1B2).

5. **Lamps** - As noted (by others). Other lamp lengths or wattages available, consult factory.

6. **Upper Shielding** - Louvers offer excellent glare control in longitudinal, lateral, and all diagonal planes. High quality aluminum louvers and acrylic shielding allow true freedom of layout for today's modern spaces.

7. **Lower Shielding** - Same options as Upper Shielding #6.

8. **Spring Steel Suspension Clips** - Supplied two places, located nominally every 4 ft. Support wires supplied and installed by others.

9. **Pre-installed 1" 1/4-20 Stud** - Attached to fixture every nominal 4 feet.

10. **Coupling and Threaded Rod to Structure** - Supplied and installed by others.

11. **Rotating Crossbar** - For inaccessible ceilings, adjustable for ceiling thicknesses from 1/4" to 2". Support required nominally every 4 feet.

12. **Steel Wall Bracket and 1/4-20 Rod** - Supplied nominally every 4 ft. (Fasteners to wall and wall anchors by others)

13. **Aluminum wallbracket** - Secured to wall (fasteners and wall anchors by others) and runs entire length of fixture. Also supplied for width of fixtures when supplied with continuous flange. Allows for 1/8" gap between flange and wall to create shadow line allowing for unevenness of wall.

**Interior Luminaire Finish** - Standard interior colors are White (WH), Black (BK) and Silver (SV). RAL colors (SP) are available, please specify RAL#.

SELUX Corp. © 2006  
TEL: (845) 691-7723  
FAX: (845) 691-6749  
www.selux.com/USA  
M1B1-01 (v5.0)



In a continuing effort to offer the best product possible, we reserve the right to change, without notice, specifications or materials that in our opinion will not alter the function of the product. Specification sheets found at www.selux.com/usa are the most recent versions and supercede all other printed or electronic versions.

# M100 Super Recessed Linear Fluorescent Flanged Extrusion



## M1B1 and M1B2 Layout Dimensions

Specify T5 lamps when using in grid ceiling systems where 24" or 48" light openings are required.

**M1B1 Recessed - nominal 4 foot individual**



**M1B1 Recessed - T-Bar Length - nominal 4 foot individual**

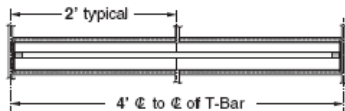

**M1B1 Recessed - nominal 8 foot individual**



**M1B1 Recessed - T-Bar Length - nominal 8 foot individual**

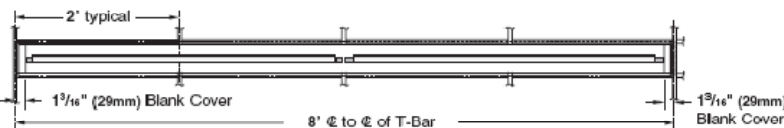

**M1B1 Recessed - nominal 12 foot individual**



**M1B1 Recessed - T-Bar Length - nominal 12 foot individual**

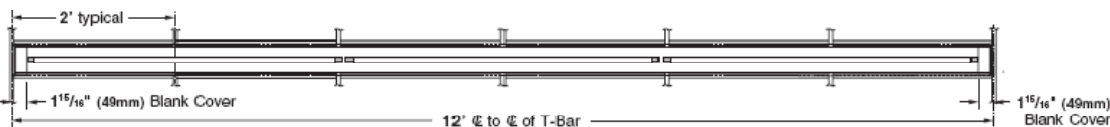

**Typical Side View**

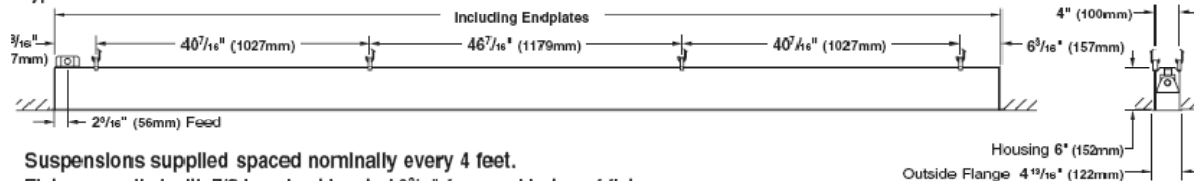

Suspensions supplied spaced nominally every 4 feet.  
Fixture supplied with 7/8 knockout located 2 3/16" from end in top of fixture.

	T5 (1 or 2 lamp)				T8 (1 lamp)	
	M1B1/M1B2 Including Endplates	M1B1 Outside Flange	M1B1/M1B2 - TB Including Endplates	M1B1 - TB Outside Flange	M1B1/M1B2 Including Endplates	M1B1 Outside Flange
<b>4 foot individual</b>	46.81' (1186mm)	47.58' (1209mm)	47.03' (1195mm)	47.91' (1216mm)	48.33' (1228mm)	49.20' (1250mm)
<b>8 foot individual</b>	93.21' (2365mm)	94.00' (2388mm)	95.03' (2414mm)	95.91' (2436mm)	96.37' (2448mm)	97.24' (2470mm)
<b>12 foot individual</b>	139.65' (3544mm)	140.41' (3567mm)	143.03' (3633mm)	143.91' (3655mm)	144.41' (3668mm)	145.28' (3690mm)

For other lengths, lamping, continuous runs or configurations please specify overall length (in feet), accessories desired and sketch/drawing of configuration. SELUX will detail project drawings upon order and supply submittal drawings for approval. Individual fixtures cannot be field joined. If you have any questions please contact SELUX customer service or applications engineering for assistance (1-800-SELUX-CS).

SELUX Corp. © 2006  
PO Box 1060, 5 Lumen Lane / Highland, NY 12528  
TEL: (845) 691-7723 / FAX: (845) 691-6749  
E-mail: seluxus@selux.com / Web Site: www.selux.com/usa  
M1B1-02 (02/06)

In a continuing effort to offer the best product possible, we reserve the right to change, without notice, specifications or materials that in our opinion will not alter the function of the product. Specification sheets found at [www.selux.com/usa](http://www.selux.com/usa) are the most recent versions and supersede all other printed or electronic versions.



# M100 Vertical Wall Mounting



## Vertical Wall Mount Application (Recessed Continuous Flange Mounting)

Ordering Code: As indicated

For use with Super Recessed (M1B1), Tannenbaum (M1N1) and Recessed (M1R1) fixtures.

Support is required nominally every 4 feet.

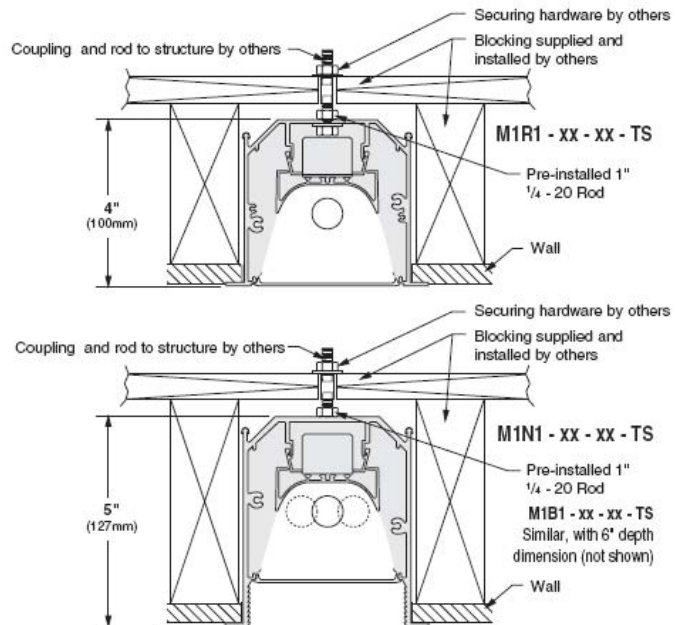
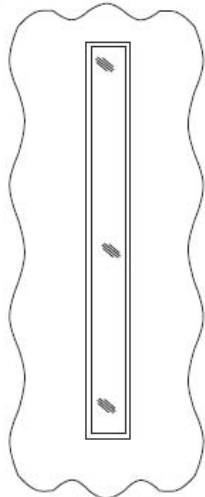

## Vertical Wall Mount Application (Recessed Spackle Flange Mounting)

Ordering Codes: As indicated

For use with Super Recessed (M1B0), Tannenbaum (M1N0) and Recessed (M10) fixtures.

Support is required nominally every 4 feet.

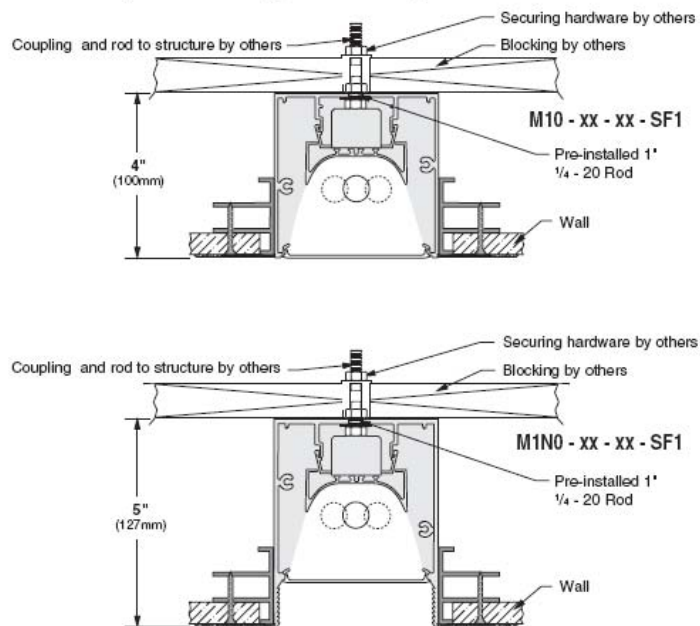
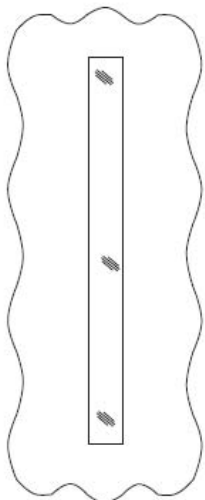

**M1B0 - xx - xx - SF1**  
Similar, with 6" depth dimension (not shown)

In a continuing effort to offer the best product possible, we reserve the right to change, without notice, specifications or materials that in our opinion will not alter the function of the product. Specification sheets found at [www.selux.com/usa](http://www.selux.com/usa) are the most recent versions and supersede all other printed or electronic versions.

SELUX Corp. © 2006  
PO Box 1060, 5 Lumen Lane / Highland, NY 12528  
TEL: (845) 691-7723 / FAX: (845) 691-6749  
E-mail: [seluxus@selux.com](mailto:seluxus@selux.com) / Web Site: [www.selux.com/usa](http://www.selux.com/usa)  
M10MNT (02/06)

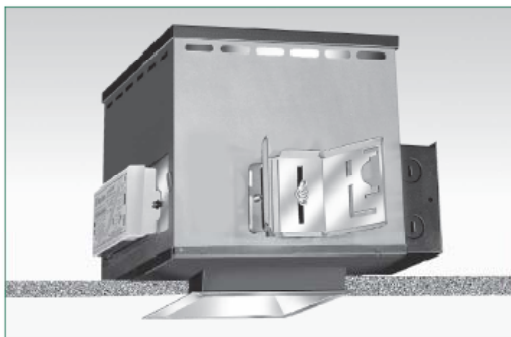
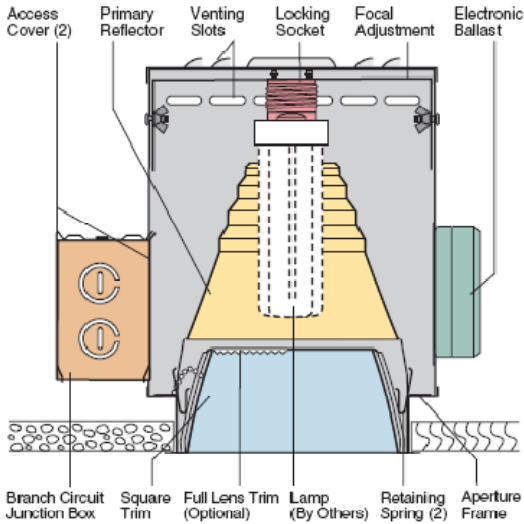

**H8632** One 26 or 32W Triple Tube  
**H8642** One 42W Triple Tube

**H22**

Compact Fluorescent Downlights  
6" Square Parabolic Trim

**Optics and Applications**

The primary reflector has a unique faceted shape designed for triple tube lamps. Distribution is for general use or task lighting. Suitable for damp locations.

**Design Features**

Steel housings protect and align reflectors and lamps. A safety locking socket prevents lamp fallout. Trims are stabilized to prevent racking and are retained by constant pressure springs. Maximum ceiling thickness 1 1/2". Top or bottom service.

**Finish**

Structural parts are painted matte black to suppress stray light leaks. Standard trims are anodized Softglow® clear. Special finishes, textures and colors are available.

**Trim Textures**

Select among different embossed patterns to match the ambience of the space being illuminated. Refer to Squares brochure for descriptive photos.

**Ballasts**

Fully electronic, microprocessor controlled with programmed start to assure rated lamp life. Input voltage ranges from 120V through 277V. Power factor .98, starting temperature 0°F (-18°C), THD<10%. Pre-heat start < 1.0 second. End of lamp life protection. Rated for > 50,000 starts.

**General**

Fixtures are pre-wired, UL and C-UL listed for eight wire 75°C branch circuit wiring. Union made IBEW. Luminaire Efficiency Rating (LER) data is in the photometric directory located in Section Z.

**Accessories**

- R2 26" support rails. WT White trim flange.
- R5 52" support rails. WHT White complete trim.
- SB Softglow black. BP Ball Peen texture.
- SG Softglow gold. CG Corrugated texture.
- SH Softglow mocha. DS Distressed texture.
- SP Softglow graphite. WV Woven texture.
- ST Softglow titanium. LL Linear spread lens.
- SW Softglow wheat. LP Large prism lens.
- SY Softglow pewter. MP Microprism lens.
- SZ Softglow bronze. DM Dimming ballast.
- BR Bright trim finish. V347 347 volt ballast.
- FC Four cell cross baffle. FR Frosting on lens, specify lens type.
- F Fuse.

EM Emergency power includes integral charger light and test switch visible through aperture. Battery operation for 90 minutes.

FLT6 Full lens trim, specify lens type, e.g. H8632-FLT6LL.  
WRL Wattage restriction label, specify wattage.

**Matching Square Units \***

- Incandescent downlights [Pages H7, H8, H9 , H10](#)
- Tungsten halogen downlights [Page H11](#)
- Low voltage downlights [Pages H5, H6](#)
- Metal halide downlights [Pages H26, H27, H28](#)

\* Click for link to pages in blue.

**Dimensions and Lamps**

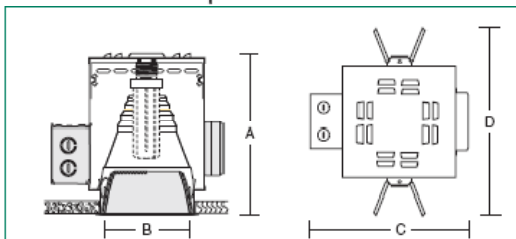

Number	A Depth	B Aperture	C Width	D Length	Lamps
H8632	1 1/4" 286mm	6" sq. 153mm	12" 305mm	14" 356mm	26-32W Triple Tube compact fluorescent
H8642	1 1/4" 286mm	6" sq. 153mm	12" 305mm	14" 356mm	42W Triple Tube compact fluorescent

**Brightness**

Number	Lamps	85°	75°	65°	55°	45°
H8632	32W PL-T Philips	55	132	224	391	10904
	32W T/E Osram/Syl	32	84	148	247	9212
H8642	42W PL-T Philips	54	147	252	436	15069
	42W T/E Osram/Syl	37	116	231	2369	15908

Data in footcandle. Photometer readings, Maximum Brightness Method.



Kurt Versen Company Point Source Lighting  
Westwood, New Jersey 07675

# H22 H8632 H8642

## Performance Datachart

Single Unit, Initial Footcandles, 30' Work Plane				Ceiling to Floor		Multiple Units, Initial Footcandles, 30' Work Plane				
H8632 One 32W Philips Read Top Data H8632 One 32W Osram Read Bottom Data						Ceiling 80% Walls 50% Floor 20%				
Nadir						Spacing is Maximum Over Work Plane				
10°										
20°										
30°										
FC	FC Diam	FC Diam	FC Diam			Spacing	RCR 1	RCR 3	RCR 8	
20	21	2'	18	4'	11	9'	7'	24	20	14
21	21	2'	17	4'	9	6'	6'	28	24	16
15	15	2'	13	5'	8	8'	8'	17	14	10
15	15	2'	12	5'	7	7'	7'	20	17	11
11	12	3'	10	5'	6	9'	9'	13	11	8
11	11	3'	9	5'	5	9'	8'	15	13	9
9	9	3'	8	6'	5	10'	10'	10	8	6
9	9	3'	7	6'	4	10'	9'	12	10	7
7	7	3'	6	7'	4	11'	11'	8	7	5
7	7	3'	6	7'	3	11'	10'	9	8	5

For 26 Watt x.88

Single Unit, Initial Footcandles, 30' Work Plane				Ceiling to Floor		Multiple Units, Initial Footcandles, 30' Work Plane				
H8642 One 42W Philips Read Top Data H8642 One 42W Osram Read Bottom Data						Ceiling 80% Walls 50% Floor 20%				
Nadir						Spacing is Maximum Over Work Plane				
10°										
20°										
30°										
FC	FC Diam	FC Diam	FC Diam			Spacing	RCR 1	RCR 3	RCR 8	
25	27	2'	22	4'	13	6'	6'	30	26	18
30	29	2'	22	4'	12	6'	6'	38	32	23
18	19	2'	16	5'	9	7'	7'	22	19	13
21	20	2'	16	5'	8	7'	7'	27	23	16
14	14	3'	12	5'	7	9'	9'	16	14	10
16	15	3'	12	5'	6	9'	8'	21	17	12
11	11	3'	9	6'	5	10'	10'	13	11	7
12	12	3'	9	6'	5	10'	9'	16	13	10
9	9	3'	7	7'	4	11'	11'	10	9	6
10	16	3'	7	7'	4	11'	10'	13	11	8

### Candlepower Distribution

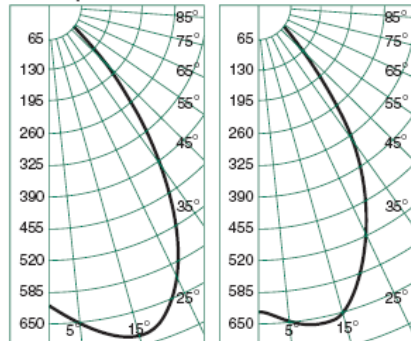

H8632 32W Philips  
Eff. 39% S/M 1.19

H8632 32W Osram  
Eff. 36% S/M 1.07

### Candelas

	P 32W	O 32W
0	620	629
5	643	650
10	678	663
15	692	648
20	673	602
25	615	529
30	517	434
35	389	339
40	283	252
45	174	166
50	41	81
55	15	25
60	11	14
65	0	10
70	0	0
75	0	0
80	0	0
85	0	0
90	0	0

° Vertical Angles  
\* Initial Lamp Lumens

### Coefficients of Utilization

Ceiling	80%				70%				50%				30%				0																																																																																																											
	70	50	30	10	50	10	50	10	50	10	50	10	50	10	50	10	50	10	0																																																																																																									
Wall %	Zonal Cavity Method - Floor Reflectance 20%																																																																																																																											
RCR	1	.44	.43	.42	.41	.42	.40	.40	.39	.39	.38	.36	.35	.36	.34	.33	2	.42	.40	.38	.36	.39	.36	.38	.35	.36	.34	.33	3	.39	.36	.34	.33	.36	.32	.35	.32	.34	.31	.30	4	.37	.34	.31	.30	.33	.29	.32	.29	.32	.29	.28	5	.35	.31	.29	.27	.31	.27	.30	.26	.29	.26	.25	6	.33	.29	.26	.25	.29	.24	.28	.24	.27	.24	.23	7	.31	.27	.24	.23	.27	.22	.26	.22	.26	.22	.21	8	.29	.25	.22	.21	.25	.21	.24	.21	.24	.21	.20	9	.28	.23	.21	.19	.23	.19	.23	.19	.22	.19	.18	10	.26	.22	.19	.18	.22	.18	.21	.18	.21	.18	.17

H8632 Osram 32W Triple Tube x .93  
H8642 Philips and Osram 42W Triple Tube x .86

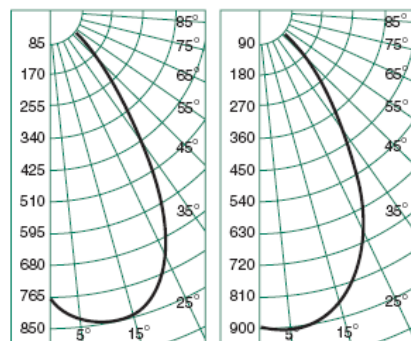

H8642 42W Philips  
Eff. 34% S/M 1.14

H8642 42W Osram  
Eff. 34% S/M 1.01

	P 42W	O 42W
0	770	898
5	814	908
10	849	903
15	850	853
20	813	797
25	724	682
30	588	550
35	436	408
40	310	297
45	176	195
50	38	86
55	17	17
60	13	12
65	0	0
70	0	0
75	0	0
80	0	0
85	0	0
90	0	0

° Vertical  
\* Initial Lamp Lumens

### Notes

- 1 For microprism spread lens multiply data x.88.
- 2 All data with standard trim, Softglow® clear.
- 3 Datachart degree headings measure one side from nadir. Diameter data includes both sides. Therefore the 20° column value describes a 40° pattern diameter at the work plane 30' above the floor. Footcandle values are at the diameter edge.
- 4 Datachart spacing is rounded off to the nearest foot.
- 5 Data by IES methods. Compact fluorescent data vary due to lamp lumen differences, power input, burning position, ambient temperature and ballast characteristics. A modification factor should be applied.
- 6 Colored trim multipliers: Gold x .90, Wheat x .85, Mocha x .80, Pewter x .80, Graphite x .75, Titanium x .75, Bronze x .70, Black x .70.

# Lighting Systems Covelite™ **CL-1**

Page 1 of 2

1-Lamp T8 Per 4' Section

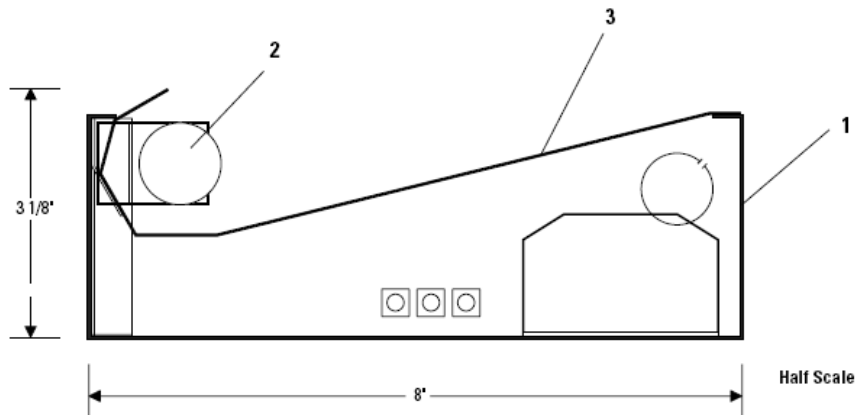

## Ordering Information

Style	Lamps	Length	Ballast & Voltage
CL	1 1 = 1 Lamp T8	4 2 = 2 Foot (24") 3 = 3 Foot (36") 4 = 4 Foot (48") 6 = 6 Foot (72") 8 = 8 Foot (96")	E82 E81 = Electronic 120V E82 = Electronic 277V HD1 = PowerSpec® HDF Dimming T8 120V HD2 = PowerSpec® HDF Dimming T8 277V

## Features

- Housing:** Die-formed 20 gauge pre-painted steel. Low profile 3 1/8" height and 8" wide.
- Lamping:** One T8 fluorescent lamp: 18 watt for 2 foot, 32 watt for 4 foot and 8 foot modules, 25 watt for 3 foot and 6 foot modules. Lamps by others.
- Reflector:** Constructed of precision die-formed specular aluminum lighting sheet. Reflector is covered with a scratch resistant protective coating to prevent damage during installation.

## Electrical

Specify 120V or 277V. 3 conductor, 18 gauge wire. Color-coded quick connectors allow ease of connection for joiner modules. For special circuiting, consult factory. Rapid start, HPF, class "P" thermally protected. PowerSpec HDF dimming ballast is available.

## Labels

UL, cUL and I.B.E.W.

Job Information	Type:
<b>Job Name:</b>	
<b>Cat. No.:</b>	
<b>Lamp(s):</b>	
<b>Notes:</b>	

Lightolier a Genlyte Thomas Company [www.lightolier.com](http://www.lightolier.com)  
 631 Airport Road, Fall River, MA 02720 • (508) 679-8131 • Fax (508) 674-4710  
 We reserve the right to change details of design, materials and finish.  
 © 2002 Genlyte Thomas Group LLC (Lightolier Division) • A0902

**LIGHTOLIER®**

# Lighting Systems Covelite™ CL-1

Page 2 of 2

1-Lamp T8 Per 4' Section

## Performance

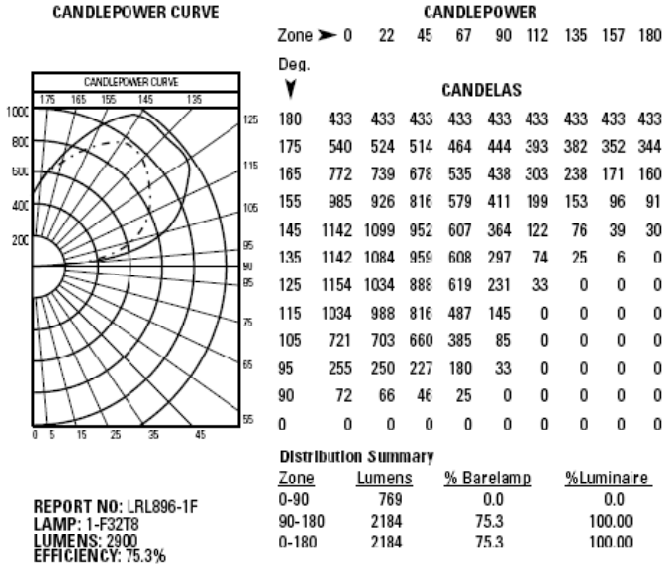

**COEFFICIENTS OF UTILIZATION**

% EFFECTIVE CEILING CAVITY REFLECTANCE

ROOM CAVITY RATIO	80						70						50					
	V			W			V			W			V			W		
	50	30	10	50	30	10	50	30	10	50	30	10	50	30	10			
1	62	59	57	53	51	49	36	35	34	35	34	33	34	33	32			
2	54	50	47	47	43	40	32	30	28	30	28	27	26	25	24			
3	48	43	39	41	37	34	28	26	24	27	24	22	21	20	19			
4	42	37	32	36	32	28	25	22	20	24	21	19	18	17	16			
5	37	31	27	32	27	24	22	20	19	22	19	17	16	15	14			
6	33	27	23	28	24	20	19	17	16	20	17	15	14	13	12			
7	29	24	20	25	21	17	17	15	14	18	15	13	12	11	10			
8	26	21	17	23	18	15	16	14	13	16	13	11	10	9	8			
9	24	19	15	21	16	13	14	12	11	14	11	9	8	7	6			
10	22	17	13	19	15	12	13	11	10	12	9	7	6	5	4			

20% FLOOR CAVITY REFLECTANCE

## Quick Calculators and Ceiling Brightness

Readings are rounded off based on initial footcandles at center of 20' run of luminaires. Room reflectance is 80% ceiling, 50% wall and 20% floor.

**1Lt, 2 Fixtures, 2 Walls, 11" from Ceiling**

Distance from wall

	0'	2'	4'	6'	8'	10'	12'	14'
11'	105	32	14	14	32	105		
8'6"	36	36	35	35	36	36		
9'6"	34	34	34	34	34	34		
10'6"	31	32	32	32	32	31		
11'6"	30	30	30	30	30	30		
12'6"	28	29	29	29	29	28		

**1Lt, 2 Fixtures, 2 Walls, 14" from Ceiling**

Distance from wall

	0'	2'	4'	6'	8'	10'	12'	14'
14'	116	44	17	17	44	116		
8'6"	35	36	35	35	36	35		
9'6"	33	34	34	34	34	33		
10'6"	31	32	32	32	32	31		
11'6"	29	30	30	30	30	29		
12'6"	27	28	29	29	28	27		

**1Lt, 1 Fixture, 1 Wall, 11" from Ceiling**

Distance from wall

	0'	2'	4'	6'	8'	10'	12'	14'
11'	100	27	8	6	5	5		
8'6"	26	24	20	15	12	10		
9'6"	23	22	18	15	12	10		
10'6"	21	20	17	15	12	10		
11'6"	19	18	16	14	12	10		
12'6"	18	17	15	14	12	10		

**1Lt, 2 Fixtures, 1 Wall, 14" from Ceiling**

Distance from wall

	0'	2'	4'	6'	8'	10'	12'	14'
14'	111	39	10	7	5	5		
8'6"	25	23	20	16	12	10		
9'6"	23	21	18	15	12	10		
10'6"	20	19	17	15	12	10		
11'6"	19	18	16	14	12	10		
12'6"	17	17	15	13	12	10		

Maximum Candle Power: 1154 CD at 125°  
 Brightness ratio on vertical wall above fixture is:  
 1:1.5 when mounted 11" from ceiling;  
 1:1.7 when mounted 14" from ceiling.

**Job Information** **Type:**

Lightolier a Genlyte Thomas Company www.lightolier.com  
 631 Airport Road, Fall River, MA 02720 • (508) 679-8131 • Fax (508) 674-4710  
 We reserve the right to change details of design, materials and finish.  
 © 2002 Genlyte Thomas Group LLC (Lightolier Division) • A0902

**LIGHTOLIER®**



Linear direct, indirect lighting element luminaires

Post construction: One piece extruded aluminum. .188" wall thickness. with one piece die cast aluminum top and base and four structural integrally extruded aluminum "fins". Access plate to ballast.

Housing: Four vertical "fins" match the pole with die cast aluminum top and bottom elements. Reflective disk of .125" thick solum aluminum.

Optical enclosure: Lamp is contained in an optical assembly comprised of an indirect reflector and direct reflective louver stack, internally semi-specular, outside finished in a matte gray anodized aluminum, enclosed in a 5½" O.D. cast, clear acrylic. Fully gasketed against water and insect infiltration.

Electrical: Lampholders: Lampholders are medium base porcelain with nickel plated copper screw shell supplied with 200°C high temperature leads, rated 4KV.

Ballast is in the pole base available in 120V or 277V, HPF - specify.

Anchor base: The #890A anchorage consists of a heavy gauge welded assembly of .157" thick galvanized steel. Luminaire slip fits over base and is secured by six (6) stainless steel socket head screws.

Finish: These luminaires are available in five standard BEGA colors: Black (BLK); White (WHT); Bronze (BRZ); Silver (SLV); Eurocoat™ (URO). To specify, add appropriate suffix to catalog number. For complete description of BEGA finishing process, refer to technical information section at end of catalog. Custom colors supplied on special order.

U.L. Listed, suitable for wet locations. Protection class: IP 65.

Type:  
 BEGA Product #:  
 Project:  
 Voltage:  
 Color:  
 Options:  
 Modified:

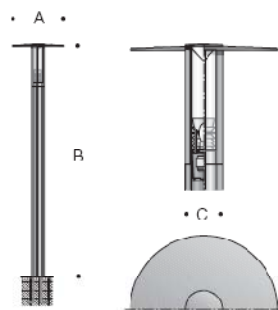

Direct/Indirect luminaire with integrated fixed height pole.  
 U.L. listed, suitable for wet locations. IP 65.  
 Colors: Standard BEGA finishes.



	Lamp	Lumen	A	B	C
<b>8996MH</b>	1 100W ED-17 MH	8600	35 7/16	15 1/2	9 1/16
<b>890A</b>	Anchorage supplied with pole for 13' - 1 1/2" O.A.H.				

BEGA/US 1000 BEGA Way, Carpinteria, CA 93013 [P] 805-684-0533 [F] 805-684-6682  
 ©Copyright BEGA/US 2005 updated 4/05

**ERCO**

# Focalflood II Floodlight

with mounting plate for metal halide lamps

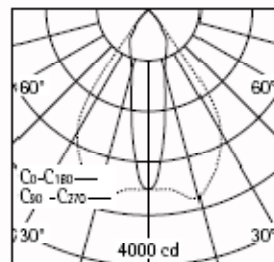
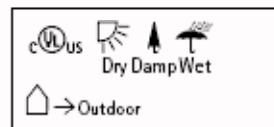
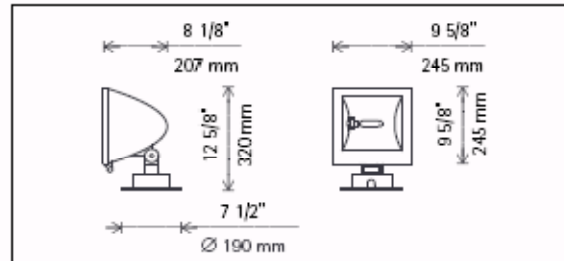

34103.023 Graphit m  
T6 39W G12 3400lm  
EOG

**Product description**

Housing and hinge: corrosion-resistant, cast aluminum, No-rinse surface treatment. Double powder-coated. Optimized surface for reduced accumulation of dirt. Hinge with internal wiring, 0-90° tilt. Luminaire rotatable through 240°. Graduated disc and mounting plate: corrosion-resistant aluminum.  
Electronic control gear 120V/277V, 60Hz. 2 cable entries. Through-wiring possible. 3-pole terminal block.  
Flood reflector with focal emphasis in beam direction: Aluminum, silver, specular anodized. Side reflectors to increase the visual comfort along the lamp axis, specular anodized. Cut-off angle 50° along the main axes. Without spill light.  
Screw-fastened cover with safety glass: corrosion-resistant cast aluminum, double powder-coated. Hinge open for lamp replacement. Suitable for wet location (IP65): dust-proof and water jet-proof.  
Weight 11.46lbs / 5.20kg  
Maximum wind load area 0.75ft²

T6 39W G12 3400lm

h(ft)	E(fc)	D	C0	C90
3	311	1'2"	4'3"	7'1"
6	78	2'4"	8'7"	
9	35	3'6"	12'10"	
12	19	4'8"	17'1"	
15	12	5'10"	21'5"	

ERCO Lighting, Inc.  
160 Raritan Center Parkway  
Suite 10  
Edison, NJ 08837  
USA  
Tel: +1 732 225 8856  
Fax: +1 732 225 8857  
info.us@erco.com

Technical Region: 120V/277V, 60Hz  
Edition: 11.15.2007  
Please download latest version from  
[www.erco.com/34103.023](http://www.erco.com/34103.023)

### Recessed wall luminaires - low voltage

**Housing:** Constructed of die cast and extruded aluminum with integral wiring compartment.

**Enclosure:** One piece die cast aluminum faceplate, tempered glass, linear prism spread lens with translucent white ceramic mask. Faceplate is secured by two (2) socket head, stainless steel, captive screws threaded into stainless steel inserts in the housing casting. Full hydroformed internal asymmetrical distribution reflector is specular anodized aluminum. Continuous high temperature O-ring gasket for weather tight operation.

**Electrical:** Low voltage lampholder: G4, bi-pin with ceramic insulator and high temperature leads. Integral electronic 120V/11.6V transformer. For dimming refer to page 326 of catalog.

**Through Wiring:** Maximum of four (4) No. 12 AWG conductors (plus ground) suitable for 75°C. Two 7/8" knockouts provided for 1/2" conduit.

**Finish:** These luminaires are available in five standard BEGA colors: Black (BLK); White (WHT); Bronze (BRZ); Silver (SLV); Eurocoat™ (URO). To specify, add appropriate suffix to catalog number. For complete description of BEGA finishing process, refer to technical information section at end of catalog. Custom colors supplied on special order.

U.L. listed, suitable for wet locations and for installation within 3 feet of ground. Suitable for all types of construction including poured concrete. Type non-IC. Protection class: IP 64.

Type: I  
 BEGA Product #:  
 Project:  
 Voltage:  
 Color:  
 Options:  
 Modified:

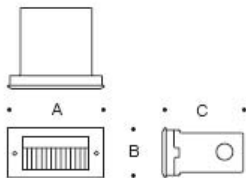

Tungsten halogen luminaire with high output. Die cast aluminum trim. Tempered glass spread lens with a translucent ceramic mask. Asymmetrical reflector. Integral 120V-11.6V electronic transformer. Lamp supplied with luminaire. Opening: 4 3/4" x 2 3/16" x 4" U.L. listed, suitable for wet locations. IP 64. Color: Standard BEGA finishes.

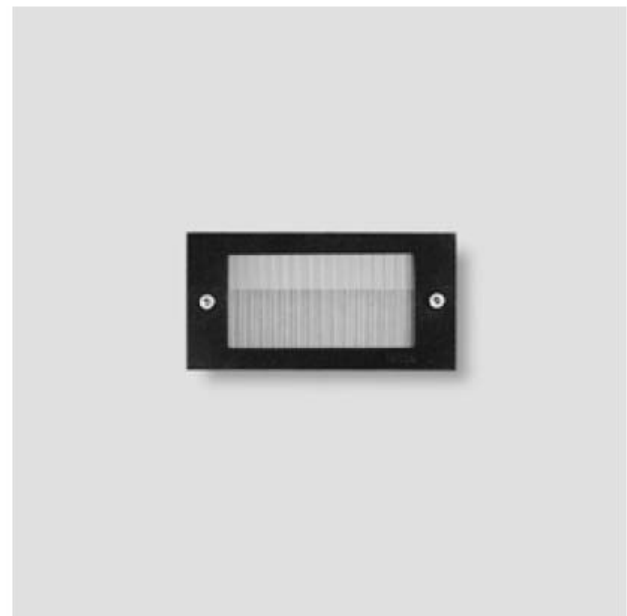

	Lamp	Lumen	A	B	C
1323	W/Spread Lens ADA 1 20W T3 G4,12V	320	5	2 3/16"	4

BEGA/US 1000 BEGA Way, Carpinteria, CA 93013 [P] 805-684-0533 [F] 805-684-6682  
 ©Copyright BEGA/US 2005 updated 4/05

# LIGHTWILD FLOOR TILE

## 2.165 inch (55 mm) WIDTH LED TILE SERIES

### TILE SPECIFICATION

ordering example: LW-TILE-FLR-RECT-2.165x11.8-FROST-B-BOX-Y

1	2	3	4	5	6	7
Part No. LW-TILE	Location FLR Floor Installation WALL Wall Installation	Shape RECT Rectangular	Dimensions 2.165 x 11.8 Width x Length	Lens FROST Frosted Lens MARB Marble Lens	LED Color WW Warm White R Red CW Cool White G Green B Blue A Amber RGB Color-changing, color-controllable	Recessed Box BOX-Y Include recessed box BOX-N Do not include recessed box

### GENERAL

- Nominal Colors:** Available in warm white\* (WW), cool white (CW)\*, blue (B), red (R), green (G), amber (A), or color-controllable RGB (RGB) LEDs
- Number of LEDs:** 72 LEDs (24 red, 24 green, 24 blue in RGB mode)
- Beam Angle:** See IES files at [www.lightwild.com/products/tilesandblocks\\_floor/tiles.asp](http://www.lightwild.com/products/tilesandblocks_floor/tiles.asp)
- Lens:** Tempered, frosted glass or tempered glass with translucent marble
- Housing:** Stainless steel
- Cable Connection:** 2- or 4-conductor (for RGB) jacketed cable with plain ends
- Ship Weight:** 10 lbs per tile
- Cable Attachment:** Cable enters back of tile
- Listings:**



### ENVIRONMENTAL

- Temperature Range:** -13 to 167 F (-25 to 75 C)
- Moisture Ingress:** IP67

### CONTROL

- Options:** LightWild offers turnkey control solutions including basic power on/off control, dimming, pre-programmed controllers for RGB fixtures, and interface to third party DMX controllers. See LightWild's Floor Tiles Control Options page for more information.

### ELECTRICAL

- Power Requirement:** 24VDC  
(Contractor supplies 120/240 VAC to control and power unit which includes a transforming power supply that delivers 24VDC to fixture.)
- Power Consumption:** 6 W (W = Watts per tile)
- Life of Bulbs:** Under ideal environmental and electrical conditions operating normal effects, LightWild's LEDs are expected to last approximately 50,000 to 80,000 hours according to LED manufacturers. As with all light sources, users can expect a depreciation in brightness during the course of this estimated lifetime. A depreciation in brightness can be expedited by a change in environmental conditions and electrical uses.  
  
\* LightWild selects from an LED bin with a range of 2700K-3200K with a goal of matching 3000K for its warm white tiles and from an LED bin with a range of 5600K-9000K with a goal of matching 7300K for its cool white tiles.



**Frosted Glass Lens**  
2.165 x 11.8 x 3.65 inches  
(55 x 300 x 92 millimeters)

**Marble Lens**  
2.165 x 11.8 x 3.9 inches  
(55 x 300 x 98 millimeters)

### TOP VIEW

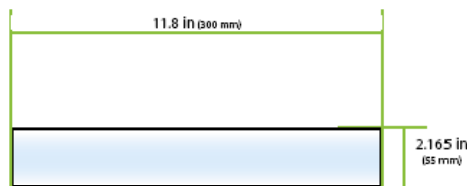

### SIDE VIEW

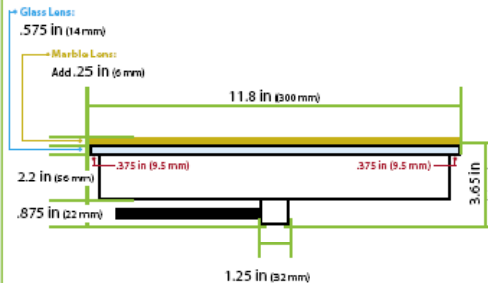

### END VIEW

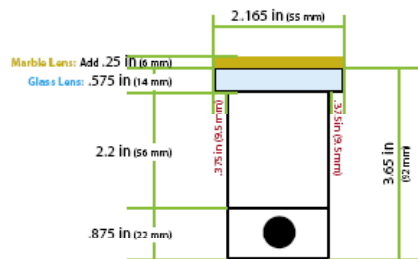

All Contents Copyright © 2007, LightWild. All Rights Reserved.

LIGHTWILD FLOOR TILES • 913-851-3000 • WWW.LIGHTWILD.COM

LIGHTWILD



# vision™ I



## FEATURES

1'x2' or 1'x4' recessed luminaire designed specifically to address teleconference lighting requirements.

Shielding may be specified in following configurations:

- Lens only
- Louver only
- Lens and Louvers

Asymmetric or Symmetric distribution models available.

Matte black louver eliminates glare.

Luminaires may be continuously row mounted.

Vision™ I is an essential part of videoconferencing lighting systems.

september 2005

## DIMENSIONAL DATA

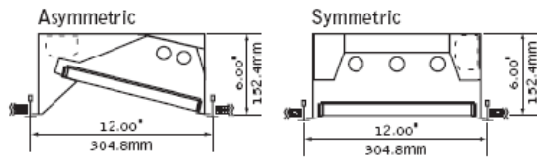

### lamping options

#### asymmetric

##### lens



##### louver



##### lens & louver



T8, T5 & T5H0 LAMPS

#### symmetric

##### lens



##### louver



##### lens & louver



T8, T5 & T5H0 LAMPS

## PERFORMANCE

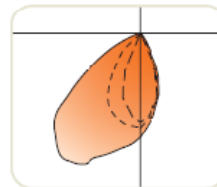

→ Lamp T5 Asymmetric  
24% Efficiency  
2210 cd @ 25°

See Photometric section for additional performance data.



fixture type:  
project name:

### DETAILS

#### mounting

specify "G" for flat 1/16" and 1/32" see or "ST" for 1/16" slot see grid types.



"G" flat see

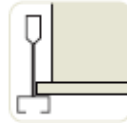

"ST" slot see  
Luminaires sit on top of 1/16" slot see grid.

Luminaires cannot be installed in T-bar ceiling systems over 1.5" high in T8 lamp configurations.

#### drywall frame kit

specify "DF" Drywall Frame Kit for drywall ceiling conditions.



Use tie-wire or screws to secure frame kit.



cut-out dimensions:  
1': Min: 12.125"  
Max: 12.563"  
4': Min: 48.125"  
Max: 48.563"

### SPECIFICATIONS

#### construction

One-piece 20 Ga. steel housing.  
One-piece 20 Ga. steel regressed bevel for asymmetric applications.  
Bottom access 20 Ga. steel ballast compartment.

2' unit weight: 12 lbs.  
4' unit weight: 22 lbs.

#### Optic

Die-formed .023" thick specular aluminum reflector  
Parallel Lower Blade: .040" aluminum, 1"H x 1" Frequency x .187" thick, Matte Black finish.  
Shielding: clear acrylic lens with K19 diagonal prismatic pattern.  
Paracube Louver: Injection molded specular silver, .75" x .75" x .5"H.

#### electrical

Electronic ballasts are thermally protected and have a Class "P" rating.  
Optional DALI and other dimming ballasts available.  
Consult factory for dimming specifications and availability.  
UL and cUL listed.

#### emergency

Emergency battery packs provide 90 minutes of illumination.  
Initial lumen output for lamp types are as follows:

T8 Lamps: Up to 475 lumens  
T5 Lamps: Up to 550 lumens  
T5HO Lamps: Up to 825 lumens

Battery pack requires unswitched not from same branch circuit as AC ballast.

#### finish

Polysster powder coat applied over a 5-stage pre-treatment.  
Standard luminaire housing finished in Matte Black.

### ORDERING

luminaire series	FTV	FTV
Vision	FTV	
nominal size		14
1' x 4'	14	
1' x 2'	12	
distribution		D
Direct Symmetrical	D	
Direct Asymmetrical	W	
lamp quantity		2
One Lamp	1	
Two Lamps	2	
Three Lamps	3	
lamp type		T5
T8	T8	
T5	T5	
T5HO	T5HO	
Asymmetric: 1, 2 or 3 Lamps		
Symmetric: 2 or 3 Lamps		
ballast		E
Electronic Instant Start <20% THD (T8 only)	E	
Electronic Program Start <10% THD	S	
Electronic Dimming Ballast (Consult factory for dimming availability)	D	
voltage		277
120 Volt	120	
277 Volt	277	
347 Volt	347	
(Consult factory for availability)		
mounting		G
Grid	G	
shielding		PB
<12 Lens	12	
Parallel Blade Louver, Black	PB	
Parallel Blade Louver, Black with K12 Overlay	PQA	
Silver Paracube, 3/4 x 3/4 x 1/2	PQ	
factory options		DF
Chicago Plenum	CP	
Drywall Frame Kit (Cut out dimensions: Min: 12.125"/Max: 12.563" Min: 24.125"/Max: 24.563" Min: 48.125"/Max: 48.563")	DF	
Emergency Battery Pack	EM	
Earthquake Clip	E0	
HLR/LLR Fuse	FU	
Flex Whip	FW	
Include 3000K Lamp	L830	
Include 3500K Lamp	L835	
Include 4100K Lamp	L841	
Separate Circuit	SC	
finish		BK
Matte Black	BK	

RECESSED

Focal Point L.L.C. 2011 South Pulaski Rd. Chicago, Illinois 60632 | T: 773.247.9999 | F: 773.247.9999 | info@focalpointlights.com | www.focalpointlights.com  
 Focal Point L.L.C. reserves the right to change specifications for products implemented without notification.

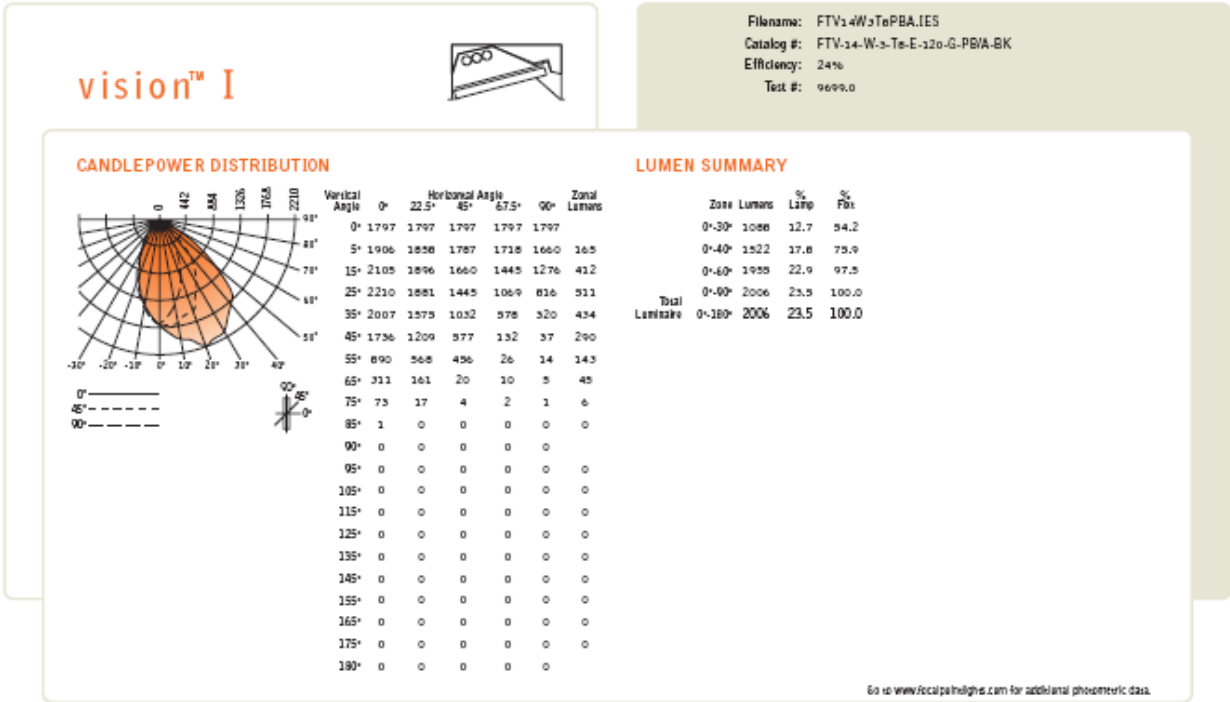

Job Name:

Type:

Order Number:

## C100 Series 120V PAR16/20



C100-00

The C100 Cylinder is a fully adjustable specification grade fixture that aesthetically conforms to most architectural spaces. It can be utilized for either accent or general lighting dependent upon the wattage and beam spread of the PAR16 or PAR20 medium screw base lamp used. Its clean appearance makes it perfect for interior spaces such as museums, galleries, exhibits, boutiques, residences and similar areas where short and medium throw applications are needed.

Optional A size accessories include: Louver, Glass Color Filters and Spread Lens, Glass UV Blocking Filter and Stainless Steel Light Blocking Screens. Integral Dimmer and Coiled Cord are also available.

Features include self-locking adjustable full steel yoke for focusing in all planes, on/off safety switch for relamping and maintenance, and multiple accessory clips that will hold a combination of any LSI accessories.

Units will also accept all of the energy conserving Halogen lamps up to 75 watts.

UL and CUL Listed  
 USA Manufactured / IDEW

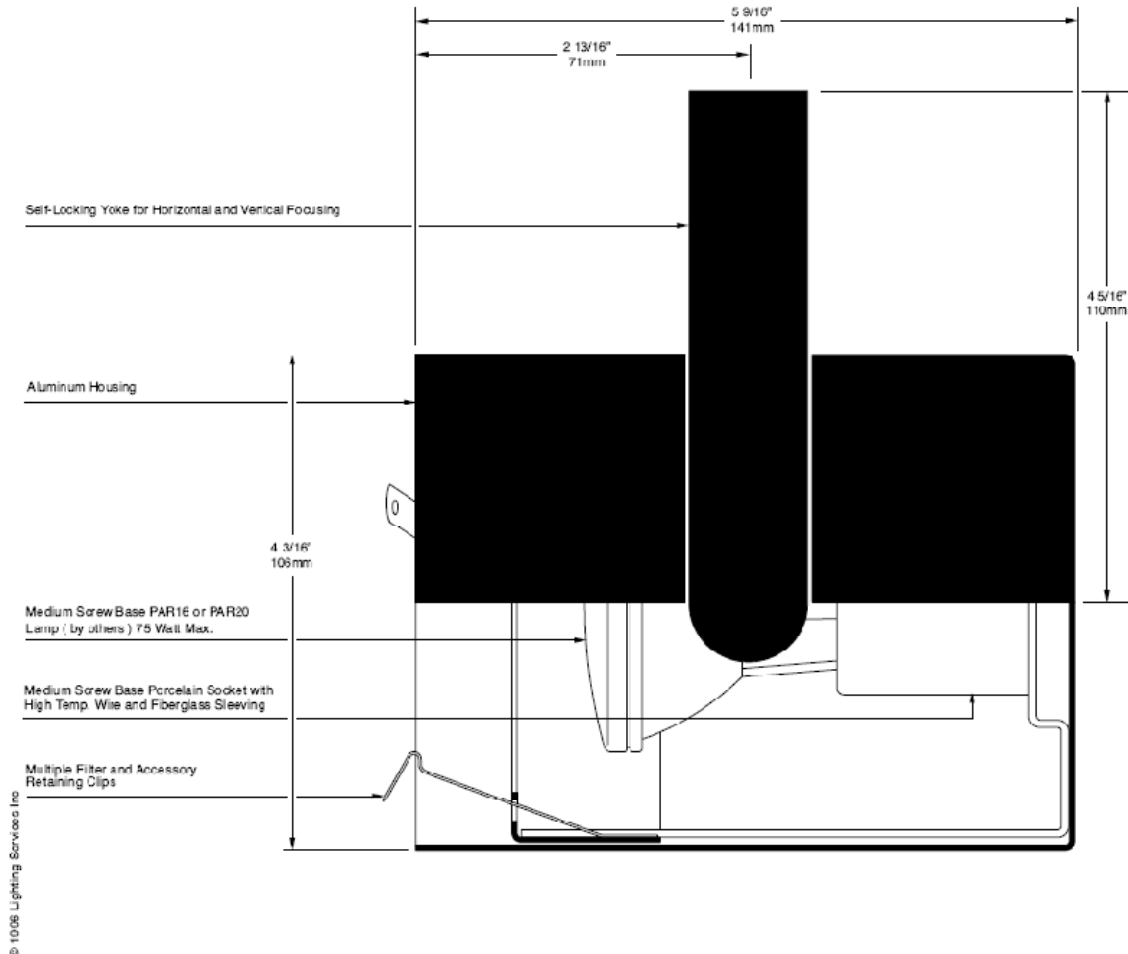

Lighting Services Inc 2 Kay Fries Drive, Stony Point NY 10980-1996 / +1 845 942-2800 Fax +1 845 942-2177 / www.LightingServicesInc.com CM035 7-06

Job Name: \_\_\_\_\_ Type: \_\_\_\_\_ Order Number: \_\_\_\_\_

# C100 Series 120V PAR16/20

### Photometric Data<sup>6</sup>

**50PAR20/H/SP10°** 50 watt, Narrow Spot  
Beam Spread to 50% of CBCP 10°  
Center Beam Candlepower 6000

**50PAR20/H/FL25°** 50 watt, Narrow Flood  
Beam Spread to 50% of CBCP 25°  
Center Beam Candlepower 1500

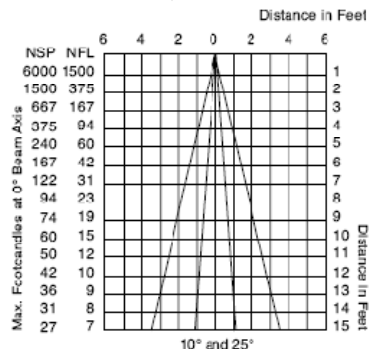

**75PAR16/CAP/NSP/10°** 75 watt, Narrow Spot  
Beam Spread to 50% of CBCP 10°  
Center Beam Candlepower 7500

**75PAR16/CAP/NFL/30°** 75 watt, Narrow Flood  
Beam Spread to 50% of CBCP 30°  
Center Beam Candlepower 1900

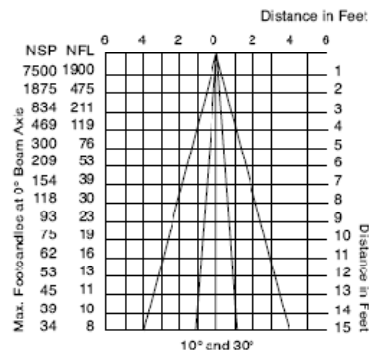

### Lamp Types

**35PAR20/CAP/NSP** 35 watt, 2500 hours  
Beam Spread to 50% of CBCP 8°  
Center Beam Candlepower 3000  
Color Temperature 2800K

**35PAR20/CAP/NFL** 35 watt, 2500 hours  
Beam Spread to 50% of CBCP 30°  
Center Beam Candlepower 900  
Color Temperature 2800K

**35PAR20/CAP/WFL** 35 watt, 2500 hours  
Beam Spread to 50% of CBCP 40°  
Center Beam Candlepower 600  
Color Temperature 2800K

**50PAR20/H/SP10°** 50 watt, 2500 hours  
Beam Spread to 50% of CBCP 10°  
Center Beam Candlepower 6000  
Color Temperature 2800K

**50PAR20/H/FL25°** 50 watt, 2000 hours  
Beam Spread to 50% of CBCP 25°  
Center Beam Candlepower 1500  
Color Temperature 2800K

**75PAR16/CAP/NSP** 75 watt, 2000 hours  
Beam Spread to 50% of CBCP 10°  
Center Beam Candlepower 7500  
Color Temperature 3000K

**75PAR16/CAP/NFL** 75 watt, 2000 hours  
Beam Spread to 50% of CBCP 30°  
Center Beam Candlepower 1900  
Color Temperature 3000K

### Accessories

**Louver A**  
1/2" cellular metal louver, controls spill light and glare, 45° cutoff.

**Glass Color Filters, Size A**  
Selection of 95 permanent rimmed dichroic, and rimmed and slotted standard colors.

**Spread Lens A990**  
Permanent glass lens for spreading light beam in one axis, 5°X 50°.

**Spread Lens A992**  
Permanent molded glass lens for spreading light beam in one axis—nominal 5°X 30°.

**Spread Lens A995**  
Permanent molded glass lens for spreading light beam in all directions—nominal 50°X 50°.

**Spread Lens A996**  
Permanent molded glass lens for spreading light beam in one direction slightly more than the other—nominal 45°X 50°.

**Beam Softener A998**  
Permanent glass lens for conditioning light to create a softer beam.

**OPTIVEX™ UV Blocking Filter A662**  
Eliminates ultra-violet wavelengths below 410±10nm. Especially useful for conservation of artworks and to help prevent fading.

**Light Blocking Screens, Size A**  
A801S-20% Light Blocking, A802S-30% Light Blocking, A803S-40% Light Blocking  
Stainless Steel Screens. Used individually or in combination to reduce transmitted light without changing its color temperature.

**Coiled Cord**  
18/3 105°C, 18" retracted, 6 foot extended. Specify by adding suffix **CC** to model number. White fixture supplied with white cord, all other finishes supplied with black cord.

**Wrench Locking**  
For permanent locking of fixture position, add "WL" to model number.

**Integral Dimmer**  
For Yoke Mounted  
Dimmer and Suffix "FD" to model number.



### Ordering Information

**Model Number**  
add suffix letters for finish

**C100-00**  
Lexan Fitting for 1 and 2 circuit LSI Track. With switch.

**C100-00F**  
Same as above, with fuse.

**C100-2G**  
Universal fitting for Unistrut Systems and any screw or bolt-up applications. With switch, 6-foot 3-wire grounding cord and plug.

**C100-3G**  
C-clamp for pipes from 5/8" to 2" O.D. With switch, 6-foot 3-wire grounding cord and plug.

**\*C100-4G**  
Cushioned weighted base for floor or table use. With switch, 6-foot 3-wire grounding cord and plug.

**C100-5A**  
Canopy for permanent mounting on standard 4" octagonal outlet boxes

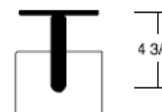
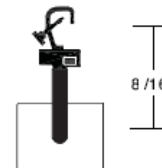
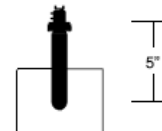

Notes:  
1. CBCP = Center Beam Candlepower  
2. K = Color Temperature in Kelvin degrees  
3. H = Halogen  
4. CAP = Capstyle  
5. OPTIVEX™ glass is a trademark of Bausch & Lomb Inc  
6. Lamp manufacturers published data  
\* Non-UL and Non-CUL

Job Name:

Type:

Order Number:

## C100 Series 120V PAR16/20



C100-00

The C100 Cylinder is a fully adjustable specification grade fixture that aesthetically conforms to most architectural spaces. It can be utilized for either accent or general lighting dependent upon the wattage and beam spread of the PAR16 or PAR20 medium screw base lamp used. Its clean appearance makes it perfect for interior spaces such as museums, galleries, exhibits, boutiques, residences and similar areas where short and medium throw applications are needed.

Optional A size accessories include: Louver, Glass Color Filters and Spread Lens, Glass UV Blocking Filter and Stainless Steel Light Blocking Screens. Integral Dimmer and Coiled Cord are also available.

Features include self-locking adjustable full steel yoke for focusing in all planes, on/off safety switch for relamping and maintenance, and multiple accessory clips that will hold a combination of any LSI accessories.

Units will also accept all of the energy conserving Halogen lamps up to 75 watts.

UL and CUL Listed  
 USA Manufactured / IBEW

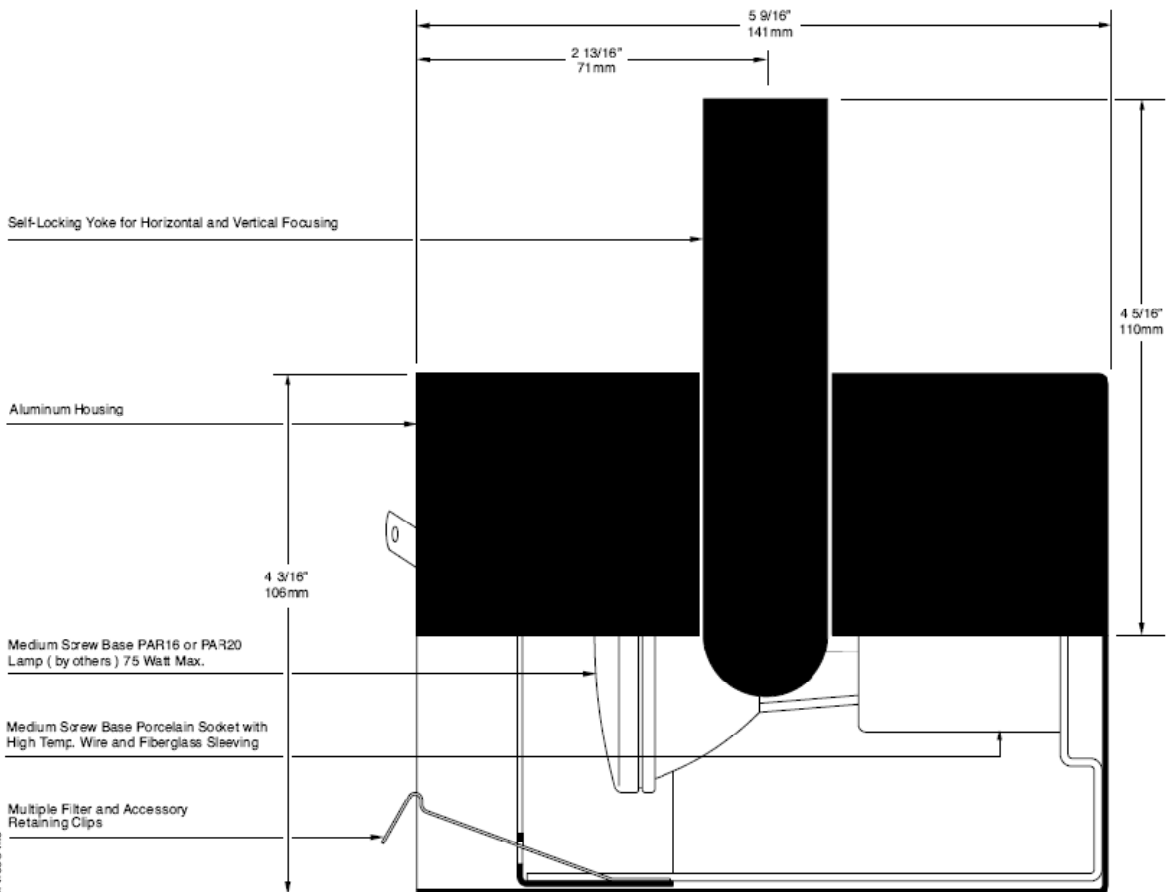

© 1996 Lighting Services Inc



Job Name: \_\_\_\_\_ Type: \_\_\_\_\_ Order Number: \_\_\_\_\_

## C100 Series 120V PAR16/20

### Photometric Data<sup>6</sup>

**50PAR20/H/SP10°** 50 watt, Narrow Spot  
Beam Spread to 50% of CBCP 10°  
Center Beam Candlepower 6000

**50PAR20/H/FL25°** 50 watt, Narrow Flood  
Beam Spread to 50% of CBCP 25°  
Center Beam Candlepower 1500

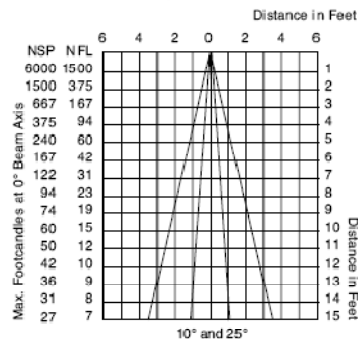

**75PAR16/CAP/NSP/10°** 75 watt, Narrow Spot  
Beam Spread to 50% of CBCP 10°  
Center Beam Candlepower 7500

**75PAR16/CAP/NFL/30°** 75 watt, Narrow Flood  
Beam Spread to 50% of CBCP 30°  
Center Beam Candlepower 1900

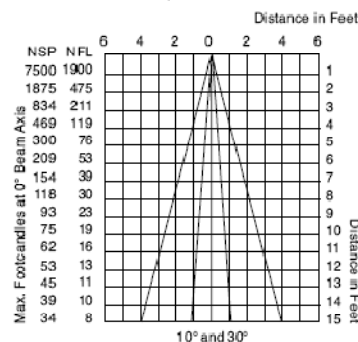

### Lamp Types

**35PAR20/CAP/NSP** 35 watt, 2500 hours  
Beam Spread to 50% of CBCP 8°  
Center Beam Candlepower 3000  
Color Temperature 2800K

**35PAR20/CAP/NFL** 35 watt, 2500 hours  
Beam Spread to 50% of CBCP 30°  
Center Beam Candlepower 900  
Color Temperature 2800K

**35PAR20/CAP/WFL** 35 watt, 2500 hours  
Beam Spread to 50% of CBCP 40°  
Center Beam Candlepower 600  
Color Temperature 2800K

**50PAR20/H/SP10°** 50 watt, 2500 hours  
Beam Spread to 50% of CBCP 10°  
Center Beam Candlepower 6000  
Color Temperature 2800K

**50PAR20/H/FL25°** 50 watt, 2000 hours  
Beam Spread to 50% of CBCP 25°  
Center Beam Candlepower 1500  
Color Temperature 2800K

**75PAR16/CAP/NSP** 75 watt, 2000 hours  
Beam Spread to 50% of CBCP 10°  
Center Beam Candlepower 7500  
Color Temperature 3000K

**75PAR16/CAP/NFL** 75 watt, 2000 hours  
Beam Spread to 50% of CBCP 30°  
Center Beam Candlepower 1900  
Color Temperature 3000K

### Accessories

#### Louwer A

1/2" cellular metal louwer, controls spill light and glare, 45° cutoff.

#### Glass Color Filters, Size A

Selection of 95 permanent rimmed dichroic, and rimmed and slotted standard colors.

#### Spread Lens A990

Permanent glass lens for spreading light beam in one axis, 5°X 50°.

#### Spread Lens A992

Permanent molded glass lens for spreading light beam in one axis—nominal 5°X 30°.

#### Spread Lens A995

Permanent molded glass lens for spreading light beam in all directions—nominal 50°X 50°.

#### Spread Lens A996

Permanent molded glass lens for spreading light beam in one direction slightly more than the other—nominal 45°X 50°.

#### Beam Softener A998

Permanent glass lens for conditioning light to create a softer beam.

#### OPTIVEX® UV Blocking Filter A962

Eliminates ultra-violet wavelengths below 410±10nm. Especially useful for conservation of artworks and to help prevent fading.

#### Light Blocking Screens, Size A

A801S-20% Light Blocking, A802S-30% Light Blocking, A803S-40% Light Blocking Stainless Steel Screens. Used individually or in combination to reduce transmitted light without changing its color temperature.

#### Coiled Cord

18/3 105°C, 18" retracted, 6 foot extended. Specify by adding suffix CC to model number. White fixture supplied with white cord, all other finishes supplied with black cord.

#### Wrench Locking

For permanent locking of fixture position, add "WL" to model number.

#### Integral Dimmer

For Yoke Mounted  
Dimmer add Suffix  
"FD" to model number.



### Ordering Information

#### Model Number

add suffix letters for finish

#### C100-00

Lexan Fitting for 1 and 2 circuit LSI Track. With switch.

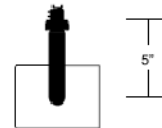

#### C100-00F

Same as above, with fuse.

#### C100-2G

Universal fitting for Unistrut Systems and any screw or bolt-up applications. With switch, 6-foot 3-wire grounding cord and plug.

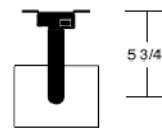

#### C100-3G

C-clamp for pipes from 5/8" to 2" O.D. With switch, 6-foot 3-wire grounding cord and plug.

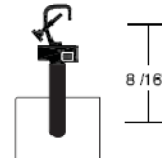

#### \*C100-4G

Cushioned weighted base for floor or table use. With switch, 6-foot 3-wire grounding cord and plug.

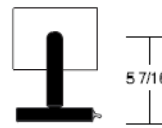

#### C100-5A

Canopy for permanent mounting on standard 4" octagonal outlet boxes

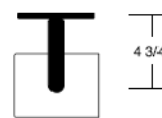

### Finishes (Paint)

Black (suffix B)  
White (suffix W)  
Silver (suffix S)  
Graphite (suffix G)  
Platinum (suffix P)

Notes:  
1. CBCP = Center Beam Candlepower  
2. K = Color Temperature in Kelvin degrees  
3. H = Halogen  
4. CAP = CapsyLite  
5. OPTIVEX® glass is a trademark of Bausch & Lomb Inc  
6. Lamp manufacturers published data  
\*Non-UL and Non-CUL

Job Name:

Type:

Order Number:

## C110 Series 120V PAR30



C110-00

The C110 Cylinder is a fully adjustable specification grade fixture that aesthetically conforms to most architectural spaces. It can be utilized for either accent or general lighting dependent upon the wattage and beam spread of the PAR30 medium screw base lamp used. Its clean appearance makes it perfect for interior spaces such as museums, galleries, exhibits, boutiques, residences and similar areas where medium throw applications are needed.

Optional B size accessories include: Louver, Glass Color Filters and Spread Lens, Glass UV Blocking Filter and Stainless Steel Light Blocking Screens. Integral Dimmer and Coiled Cord are also available.

Features include self-locking adjustable full steel yoke for focusing in all planes, on/off safety switch for relamping and maintenance, and multiple accessory clips that will hold a combination of any LSI accessories.

Units will also accept all of the energy conserving Halogen lamps up to 75 watts.

UL and CUL Listed  
 USA Manufactured / IBEW

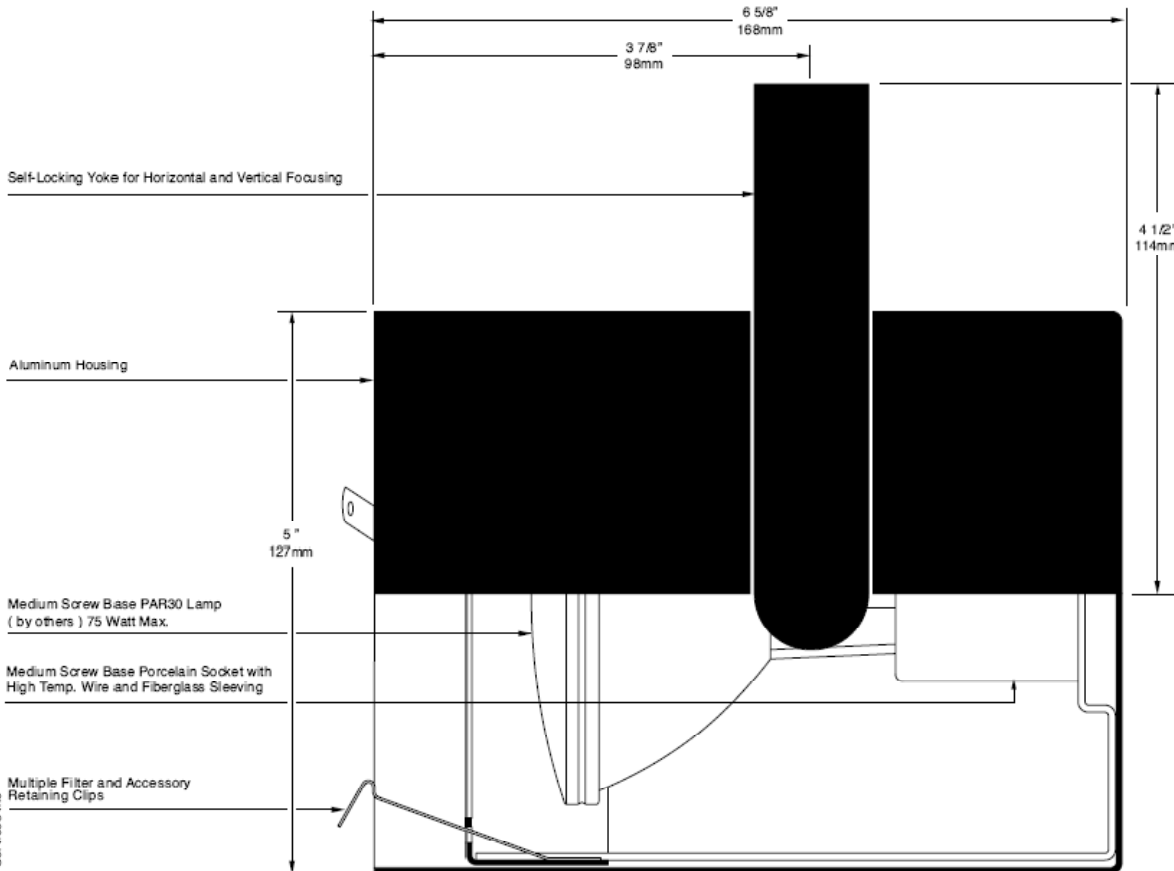

Job Name:  Type:  Order Number:

# C110 Series 120V PAR30

### Photometric Data<sup>6</sup>

<b>75PAR30/H/SP10°</b> 75 watt, Narrow Spot	<b>75PAR30/H/FL35°</b> 75 watt, Flood	
Beam Spread to 50% of CBCP	Beam Spread to 50% of CBCP	35°
Center Beam Candlepower	Center Beam Candlepower	2000
<b>75PAR30/H/FL25°</b> 75 watt, Narrow Flood		
Beam Spread to 50% of CBCP		25°
Center Beam Candlepower		3100

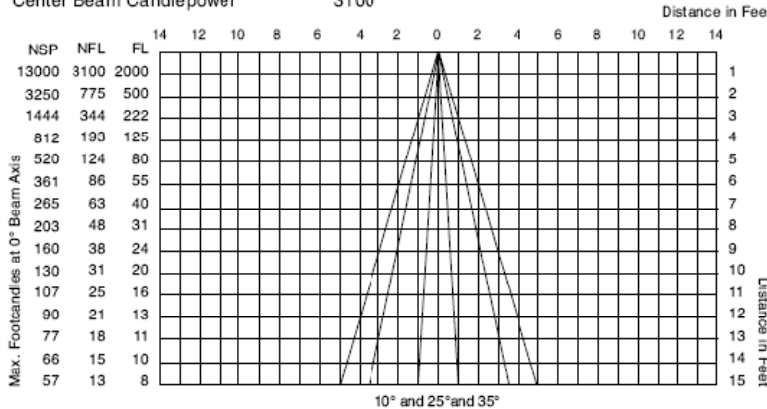

### Lamp Types

<b>50PAR30/HIR/SP9°</b> 50 watt, 3000 hours	
Beam Spread to 50% of CBCP	9°
Center Beam Candlepower	13000
Color Temperature	2810K
<b>50PAR30/HIR/FL25°</b> 50 watt, 3000 hours	
Beam Spread to 50% of CBCP	25°
Center Beam Candlepower	2700
Color Temperature	2810K
<b>50PAR30/HIR/FL35°</b> 50 watt, 3000 hours	
Beam Spread to 50% of CBCP	35°
Center Beam Candlepower	1500
Color Temperature	2810K

<b>60PAR30/H/SP10°</b> 60 watt, 3000 hours	
Beam Spread to 50% of CBCP	10°
Center Beam Candlepower	10000
Color Temperature	2800K

<b>60PAR30/H/FL25°</b> 60 watt, 3000 hours	
Beam Spread to 50% of CBCP	25°
Center Beam Candlepower	2400
Color Temperature	2800K

<b>60PAR30/H/FL35°</b> 60 watt, 3000 hours	
Beam Spread to 50% of CBCP	35°
Center Beam Candlepower	1700
Color Temperature	2800K

<b>75PAR30/H/SP10°</b> 75 watt, 2000 hours	
Beam Spread to 50% of CBCP	10°
Center Beam Candlepower	13000
Color Temperature	2830K

<b>75PAR30/H/FL25°</b> 75 watt, 2000 hours	
Beam Spread to 50% of CBCP	25°
Center Beam Candlepower	3100
Color Temperature	2830K

<b>75PAR30/H/FL35°</b> 75 watt, 2000 hours	
Beam Spread to 50% of CBCP	35°
Center Beam Candlepower	2000
Color Temperature	2830K

### Accessories

- Louwer B**  
1/2" cellular metal louwer, controls spill light and glare, 45° cutoff.
- Glass Color Filters, Size B**  
Selection of 95 permanent rimmed dichroic, and rimmed and slotted standard colors.
- Spread Lens B990**  
Permanent glass lens for spreading light beam in one axis, 5°X 50°, rimmed and slotted for heat expansion.
- Spread Lens B992**  
Permanent molded glass lens for spreading light beam in one axis—nominal 5°X 30°.
- Spread Lens B995**  
Permanent molded glass lens for spreading light beam in all directions—nominal 50°X 50°.
- Spread Lens B996**  
Permanent molded glass lens for spreading light beam in one direction slightly more than the other—nominal 45°X 50°.
- Beam Softener B998**  
Permanent glass lens for conditioning light to create a softer beam.
- OPTIVEX™ UV Blocking Filter B962**  
Eliminates ultra-violet wavelengths below 410±10nm. Especially useful for conservation of artworks and to help prevent fading.
- Light Blocking Screens, Size B**  
B801S-20% Light Blocking, B802S-30% Light Blocking, B803S-40% Light Blocking Stainless Steel Screens. Used individually or in combination to reduce transmitted light without changing its color temperature.
- Coiled Cord**  
18/3 105°C, 18" retracted, 6 foot extended. Specify by adding suffix CC to model number. White fixture supplied with white cord, all other finishes supplied with black cord.

### Ordering Information

**Model Number**  
add suffix letters for finish

**C110-00**  
Lexan Fitting for 1 and 2 circuit LSI Track. With switch.

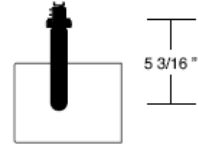

**C110-00F**  
Same as above, with fuse.

**C110-2G**  
Universal fitting for Unistrut Systems and any screw or bolt-up applications. With switch, 6-foot 3 wire grounding cord and plug.

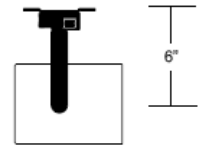

**C110-3G**  
C-clamp for pipes from 5/8" to 2" C.D. With switch, 6-foot 3-wire grounding cord and plug.

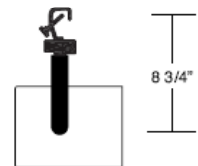

**C110-4G**  
Cushioned weighted base for floor or table use. With switch, 6-foot 3-wire grounding cord and plug.

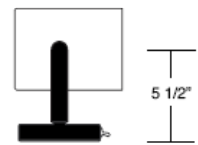

**C110-5A**  
Canopy for permanent mounting on standard 4" octagonal outlet boxes

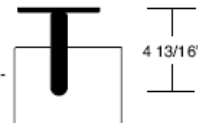

**Wrench Locking**  
For permanent locking of fixture position, add "WL" to model number.

**Integral Dimmer**  
For Yoke Mounted Dimmer add Suffix "FD" to model number.

**Finishes (Paint)**  
Black (suffix B)  
White (suffix W)  
Silver (suffix S)  
Graphite (suffix G)  
Platinum (suffix P)

Notes:  
1. CBCP = Center Beam Candlepower  
2. K = Color Temperature in Kelvin degrees  
3. H = Halogen  
4. HIR = Halogen Infra Red  
5. OPTIVEX™ glass is a trademark of Bausch & Lomb  
6. Lamp manufacturers published data  
\* Non-UL and Non-CUL



**COLORBLAZE 48**



The ColorBlaze® 48 fixture washes large areas with far-reaching, rich, saturated colors and color-changing lighting effects. The streamlined, four-foot black metal housing provides a simple yet powerful solution for large-area scenery and wash lighting for theaters, TV and video studios, concerts, events, casinos, and exhibits. On-board power supplies and addressing capabilities eliminate the need for dedicated support equipment and simplifies specification and installation. The auto-switching power supplies work around the world.

Designed in a rugged extruded aluminum housing, each fixture features attached mounting brackets with two, 1/2-inch (13 mm) mounting holes for use with Cheeseborough clamps or pipe clamps. Locking knobs located on the mounting brackets allow for 180° rotational adjustment and locking without the use of special tools. Optional mounting brackets are available for T-handle mount applications. The housing is equipped to support spread lenses, louvers, and other attachments. A single 3-wire, 18AWG 6-foot (1.8 m) UL/cUL rated cord with IEC and flying leads is supplied. (Consult distribution for cord sets listed for PSE or CE).

Each ColorBlaze 48 fixture has eight individual circuit board assemblies, each with 18 high-intensity LEDs. This makes it sequentially controllable in 6-inch increments by a Color Kinetics DMX controller or a third-party DMX512 controller. Each circuit board is pre-addressed for Light# 1-8/DMX# 1-24. Data can be daisy-chained from fixture to fixture with an RJ-45 data cable or an XLR-5 data cable.

For protection from overheating, ColorBlaze 48 has been designed with a temperature monitoring feature. If operating temperatures rise to an unsafe level, a compensation circuit is triggered and ColorBlaze 48 operation is interrupted causing the lights to turn dull red. After 30 minutes the lights will auto-cycle and return to full intensity.

**COLORBLAZE 48 SPECIFICATIONS**

<b>COLOR RANGE</b>	16.7 million (24 bit) additive RGB colors; continuously variable intensity output range
<b>SOURCE</b>	High intensity power light emitting diodes (LEDs)
<b>BEAM ANGLE</b>	10°
<b>HOUSING</b>	Extruded aluminum with black finish
<b>POWER CONNECTOR</b>	IEC 15A (max) with C13 plug, UL/cUL rated 2-pole, 3-wire, grounded, 15A, flying leads
<b>DATA CONNECTORS</b>	RJ-45 or XLR-5
<b>LISTINGS</b>	UL/cUL, CE, PSE

**COMMUNICATION SPECIFICATIONS**

<b>DATA INTERFACE</b>	DMX512
<b>CONTROL</b>	Color Kinetics' line of DMX controllers or other DMX512 (RS-485) controllers

**ELECTRICAL SPECIFICATIONS**

<b>POWER REQUIREMENT</b>	100-240VAC
<b>POWER CONSUMPTION</b>	280W, 2.5A nominal at full intensity (full RGB)

**ENVIRONMENTAL SPECIFICATIONS**

<b>TEMPERATURE RANGE</b>	-40°F to 122°F (-40°C to 50°C) operating temperature 14°F to 122°F (-10°C to 50°C) starting temperature
--------------------------	--

**LED SOURCE LIFE**

In traditional lamp sources, lifetime is defined as the point at which 50% of the lamps fail. This is also termed Mean Time Between Failure [MTBF]. LEDs are semiconductor devices and have a much longer MTBF than conventional sources. However, MTBF is not the only consideration in determining useful life. Color Kinetics uses the concept of useful light output for rating source lifetimes. Like traditional sources, LED output degrades over time (lumen depreciation) and this is the metric for SSL lifetime.

LED lumen depreciation is affected by numerous environmental conditions such as ambient temperature, humidity and ventilation. Lumen depreciation is also affected by means of control, thermal management, current levels, and a host of other electrical design considerations. Color Kinetics systems are expertly engineered to optimize LED life when used under normal operating conditions. Lumen depreciation information is based on LED manufacturers' source life data as well as other third party testing. Low temperatures and controlled effects have a beneficial effect on lumen depreciation. Overall system lifetime could vary substantially based on usage and the environment in which the system is installed.

Temperature and effects will affect lifetime. Color Kinetics rates product lifetime using lumen depreciation to 50% of original light output. When the fixture is running at room temperature using a color wash effect, the range of lifetime is in the range of 80,000-100,000 hours. This is LED manufacturers' test data. High output is defined as any LED device that is 1/2 watt or above. For more detailed information on source life, please see [www.colorkinetics.com/lifetime](http://www.colorkinetics.com/lifetime).

**OPTIBIN®**

There are inherent variations in the fabrication processes of all semiconductor materials. For LEDs, this variance results in differences in the color and intensity of light output as well as electrical characteristics. Due to these differences, LED manufacturers sort production into "bins," but insuring the availability of a single bin is very difficult. To minimize this issue and achieve optimal color consistency in its products, Color Kinetics has developed and uses a proprietary technology called Optibin. Optibin is an advanced production binning optimization process that minimizes the effects of LED variance for the best possible output uniformity in the final product. Color Kinetics Optibin technology gives the most consistent control of color and intensity from product to product.

**CHROMACORE®**  
BY COLOR KINETICS

**OPTIBIN®**  
BY COLOR KINETICS



ITEM#116-000016-00

This product is protected by one or more of the following U.S. patents and their foreign counterparts: 6,016,038, 6,150,774, 6,292,901, 6,340,868, 6,777,891, 6,788,011, 6,806,659, 6,969,954, 6,975,079, 7,186,003, and 7,221,104. Other patents pending.

Copyright © 2003-2007 Color Kinetics Incorporated. All rights reserved.

Chromacore, Chromatic, CK, the CK logo, Color Kinetics, the Color Kinetics logo, Color Kinetics The Leader in Intelligent Light, ColorBlast, ColorBlaze, ColorBurst, ColorCast, ColorPlay, ColorScope, DIMand, Direct Light, EssentialWhite, eW, iColor, iColor Cove, IntelliWhite, iW, iFoyer, Light Without Limits, Optibin, Powercore, QuickPlay, Source, the Source logo, and Smarttutor are either registered trademarks or trademarks of Color Kinetics Incorporated in the United States and/or other countries.

All other brand or product names are trademarks or registered trademarks of their respective owners.

BR0116 Rev 07

Specifications subject to change without notice. Refer to [www.colorkinetics.com](http://www.colorkinetics.com) for the most recent data sheet versions.

PHILIPS SOLID-STATE LIGHTING SOLUTIONS • 3 BURLINGTON WOODS DRIVE • BURLINGTON, MA 01803 • USA  
TEL 888 FULL RGB • TEL 617 423 9999 • FAX 617 423 9998 • INFO@COLORKINETICS.COM • WWW.COLORKINETICS.COM



**COLORBLAZE 48**

PHOTOMETRIC PERFORMANCE

Photometric data is based on test results from an independent testing lab.

**SOURCE SPECIFICATIONS**

Optics: Clear polycarbonate  
 Source: 144 LEDs (48 Red, 48 Green, 48 Blue)  
 Beam Angle: 10° (at 50% of peak illuminance)  
 Distribution: Symmetric direct illumination  
 CCT: Adjustable 1,000 – 10,000K  
 CRI: Not measurable (CIE 13.3-1995)

**ILLUMINANCE DISTRIBUTION**

7.9 85.0	10.7 115.2	11.9 128.1	11.4 122.7	9.6 103.3	6.9 74.3	6.0'/2.0m
15.3 164.7	25.3 272.3	29.3 315.4	27.6 297.1	19.1 205.6	10.0 107.6	
52.8 568.3	99.1 1066.7	107.0 1151.7	109.0 1173.3	68.0 732.0	18.0 193.8	3.0'/1.0m
59.0 635.1	144.0 1550.0	183.0 1969.8	183.0 1969.8	140.0 1507.0	54.6 587.7	
23.4 251.9	82.5 888.0	127.0 1367.0	125.0 1345.5	112.0 1205.6	57.3 616.8	
10.1 108.7	25.5 274.5	38.9 418.7	40.5 435.9	35.4 381.0	19.6 211.0	0.0'/0.0m
	3.0'/1.0m	0'/0m		3.0'/1.0m		

Units: Footcandles (top)/Lux (bottom)  
 10.8 lux = 1 fc  
 Measured on: All, reflectance model 80/50/20%  
 Distance from surface: Bottom of grid, 3' (1.0 m) from surface, light at a 45° angle off horizontal

**CANDLE POWER DISTRIBUTION**

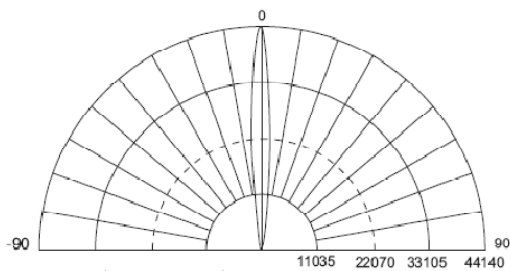

Measured on: White  
 Beam center: 44140 cd  
 Thin dashed line: Indicates 50% of peak  
 Multipliers: 0.33 Red, 0.50 Green, 0.18 Blue

**ILLUMINANCE**

COLOR	3'	6'	9'	15'
	1m	2m	3m	5m
WHITE	2162.0 23271.8	675.0 7265.7	253.0 2723.3	127.0 1367.0
RED	721.2 7763.5	225.2 2423.8	84.4 908.5	42.4 456.0
GREEN	1070.2 11519.5	334.1 3596.5	125.2 1348.0	62.9 676.7
BLUE	393.5 4235.5	122.9 1322.4	46.0 495.6	23.1 248.8

Measured in Footcandles (top)/Lux (bottom) on axis.  
 Measured on: All, reflectance 0.

**LIGHT OUTPUT**

COLOR	TOTAL OUTPUT (lumens)	POWER (Watts)	EFFICACY (Lm/W)
WHITE	2282	240.0	9.5
RED	761.3	84.0	9.1
GREEN	1129.6	84.0	13.4
BLUE	415.3	84.0	4.9

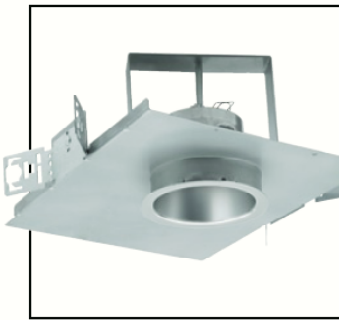

## 4" LED Downlight

### D4LED

Wet Location  
120V, 277V

#### APPLICATIONS:

Architektür D4LED is a 4" specification grade LED downlight that provides superior brightness control. The D4LED is suitable for a variety of commercial, retail, and institutional applications, including outdoor cold environments.

Fixture should be installed in applications where ambient temperatures do not exceed 50°C (122°F) while illuminated. Installations in applications that exceed this temperature will result in a reduction of lamp life and void product warranty.

#### HOUSING:

One-piece 18 gauge steel platform. Pre-wired J-Box with snap-on cover for easy access.

#### REFLECTOR:

High purity spun aluminum reflector with iridescence suppressed Alzak anodized reflector. Reflector/Light Engine assembly is attached to the housing with a Truss head tamper proof screw (tool required). Self flanged reflector. Painted white trim available as option.

#### LED LIGHT ENGINE:

Each equipped with (4) 3-Watt white Lumileds Luxeon K2 LEDs with integral heat sink that will provide 70% average lumen maintenance at 50,000 hours. LED board is attached to the heat sink with two pin in socket button head tamper proof screws. One #8 tamper proof bit included.

#### LED DRIVER:

Solid state electronic 700mA, FCC class B compliant, 24V. 50,000 hour minimum anticipated life. Rated for -40°C/F starting temperature.

Stepdown transformer for 277V option.

#### LABELS:

CSA C/US listed suitable for wet location under covered ceiling. Approved for through wiring. Non-IC rated.

DATE: \_\_\_\_\_ TYPE: \_\_\_\_\_

FIRM NAME: \_\_\_\_\_

PROJECT: \_\_\_\_\_

**Architektür**

Ceiling Cutout: 5 3/8"  
Contact Factory For Shallow Ceiling  
Maximum Ceiling Thickness 1 1/4"  
For conversion to millimeters,  
multiply inches by 25.4  
Not to Scale

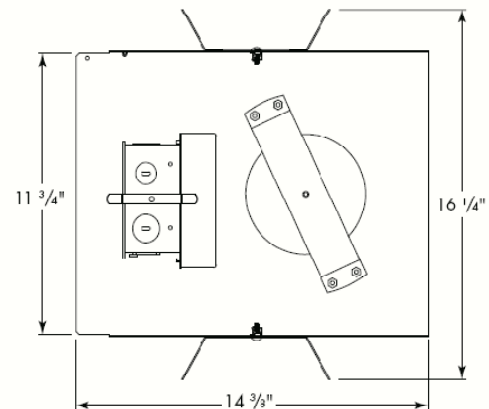
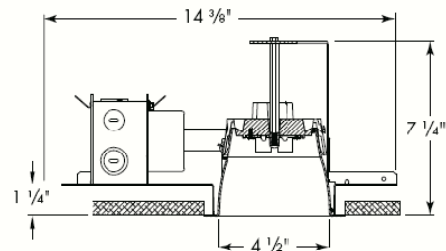

CATALOG NUMBER:

EXAMPLE: D4LED277V-4D9MFC

HOUSING	HOUSING OPTIONS	TRIM	REFLECTOR FINISH	REFLECTOR COLOR	REFLECTOR OPTIONS	ACCESSORIES
<input type="checkbox"/> <b>D4LED</b> 4" LED Housing	<input type="checkbox"/> <b>277V</b>	<input type="checkbox"/> <b>4D9</b> 4" Open Reflector/Light Engine Assembly	<input type="checkbox"/> <b>BLANK</b> Specular <input type="checkbox"/> <b>SS</b> Semi-Specular <input type="checkbox"/> <b>MFC</b> American Matte	<input type="checkbox"/> <b>BLANK</b> Clear Alzak <input type="checkbox"/> <b>CG</b> Champagne Gold Alzak <input type="checkbox"/> <b>BL</b> Black Alzak <input type="checkbox"/> <b>WE</b> Wheat Alzak <input type="checkbox"/> <b>LW</b> Light Wheat Alzak <input type="checkbox"/> <b>PW</b> Pewter Alzak <input type="checkbox"/> <b>WH</b> <sup>1</sup> White Paint	<input type="checkbox"/> <b>WT</b> White Trim <input type="checkbox"/> <b>TRG</b> Trim Ring Gasket (factory installed)	<input type="checkbox"/> <b>B24</b> Set of two(2) 24" bar hangers for T-bar ceilings <input type="checkbox"/> <b>B6</b> Set of two (2) bar hangers for ceiling joist up to 24" centers <input type="checkbox"/> <b>SCA5</b> Sloped ceiling adapter for 4" housings. Specify degree of slope and type of ceiling. Slope ceiling adapter and housing must be installed at the same time.

<sup>1</sup>Requires WT option.

In a continuing effort to offer the best product possible we reserve the right to change, without notice, specifications or materials that in our opinion will not alter the function of the product.  
Web: [www.prescolite.com](http://www.prescolite.com) • Tech Support: (888) 777-4832



**ARCH-LED-001**



# PHOTOMETRIC DATA

# Architektūr - 4" D4LED Downlight

### D4LED/4D9

Lamp: Four 3-watt White LEDs (Lumileds K2)  
Spacing Criteria = 0.4  
Efficiency = 101.8%\*\*

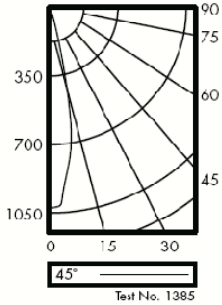

### CANDLEPOWER SUMMARY

Angle	45°
0	1038
5	919
15	414
25	47
35	13
45	6
55	0
65	0
75	0
85	0
90	0

### ZONAL LUMEN SUMMARY

ZONE	LUMENS	%LAMP	%LUMINAIRE
0-30	219	96.3	94.5
0-40	228	100.2**	98.4
0-60	232	101.8**	100.0
0-90	232	101.8**	100.0
90-180	0	0.0	0.0
0-180	232	101.8**	100.0

### LUMINANCE DATA IN CANDELA/SQ. METER

Angle in Vertical	Average
45	1046
55	0
65	0
75	0
85	0

INPUT PARAMETER	VALUE	UNITS
Input Voltage range	120 ± 10%	V
Frequency	60	Hz
Power	15	W
Current	0.125	A
Efficiency	80	%

### D4LED/4D9 AVERAGE INITIAL FOOTCANDLES

- Assumptions:
- Multiple Units (Square Array)
  - Ceiling 80% Wall 50% Floor 20%
  - 4 fixtures evenly spaced in the center of the room.
  - The room is square and has a width and length equal to twice the lamp spacing.
  - The lumen depreciation factor is 0.8
  - The dirt depreciation factor is 0.98

### OPTICAL CHARACTERISTICS

Color	Color Temperature			Lumens
	Min.	Typ	Max.	TYP
White	5,000 K	5,500 K	6,000 K	57

3W SPACING	LED RCR1	RCR3	RCR7
7.0	4	4	3
8.0	3	3	3
9.0	3	2	2
10.0	2	2	2
11.0	2	2	1
12.0	1	1	1
13.0	1	1	1
14.0	1	1	1
15.0	1	1	1

Test No. 1385

### COEFFICIENTS OF UTILIZATION Zonal Cavity Method

Room Cavity Ratio	% Effective Floor Cavity Reflectance																			
	80%				70%				50%				30%				10%			
	20% Effective Floor Cavity Reflectance																			
	% Wall Reflectance																			
	70	50	30	10	70	50	30	10	50	30	10	50	30	10	50	30	10			
1	118	115	114	112	115	113	112	110	109	108	107	106	105	104	102	101	101			
2	114	110	107	105	112	109	106	104	105	103	101	102	101	99	100	98	97			
3	110	106	102	99	109	104	101	98	102	99	97	100	97	95	97	95	94			
4	107	102	98	95	105	101	97	94	99	96	93	97	94	92	95	93	91			
5	104	98	94	91	103	97	93	91	96	92	90	94	91	89	93	90	88			
6	101	94	91	88	100	94	90	87	93	89	87	92	89	86	90	88	86			
7	98	92	88	85	97	91	87	85	90	87	84	89	86	84	88	85	83			
8	96	89	85	82	95	89	85	82	88	84	82	87	84	81	86	83	81			
9	93	87	83	80	92	86	82	80	85	82	79	85	82	79	84	81	79			
10	91	84	80	78	90	84	80	78	83	80	77	83	79	77	82	79	77			

D4LED/4D9

Test No. 1385

\*LEDs have inherent variances in light output of +/- 10% of rated lumens. The above published data assumes a weighted average of 57 lumens/LED.

\*\*Efficiency > 100% because the luminaire's thermal management causes LED array to produce more lumens when installed in the luminaire than in free air.

### NOTES

Refer to [www.prescolite.com](http://www.prescolite.com) for additional photometric tests (IES Files).



Web: [www.prescolite.com](http://www.prescolite.com) • Tech Support: (888) 777-4832  
701 Millennium Blvd., Greenville, SC 29607 U.S.A. • Phone (864) 676-1000  
Copyright ©2007 Prescolite, Inc., a division of Hubbell Lighting, Inc. All Rights Reserved.  
Specifications subject to change without notice. • Printed in U.S.A. • ARCHLED-001 • 06/11/07



Hubbell Lighting, Inc.

# Lamp Cut Sheets

T5 Mini Bipin

## PENTRON® T5 LAMPS PENTRON® High Performance T5 Lamps

Nominal Wattage	Bulb	Nominal Length (in)	MCL (in)	Base	Product Number	Ordering Abbreviation	Pkg Qty	Avg Rated Life (hrs)	CCT (K)	CRI	Approx Lumens		Symbols & Footnotes	
											Initial @25°C/77°F	Mean @35°C/95°F		
21	T5	36	34	Mini Bipin	20924	FP21.841/ECO	40	20000	4100	82	1890 2100	1767 1953	☀️☑️1,2,6, 8,9,11	
28	T5	48	45.8	Mini Bipin	20838	FP28.60[RED]	40	10000				2100		1,2,8,9,11
					20839	FP28.66[GREEN]	40	10000				3500		1,2,8,9,11
					20840	FP28.67[BLUE]	40	10000				700		1,2,8,9,11
					20836	FP28.830	40	20000	3000	82	2600 2900	2418 2697	☑️1,2,8,9,11	
					20868	FP28.830/ECO	40	20000	3000	82	2600 2900	2418 2697	☀️☑️1,2,6, 8,9,11	
					20841	FP28.835	40	20000	3500	82	2600 2900	2418 2697	☑️1,2,8,9,11	
35	T5	60	57.6	Mini Bipin	20901	FP28.835/ECO	40	20000	3500	82	2600 2900	2418 2697	☀️☑️1,2,6, 8,9,11	
					20842	FP28.841	40	20000	4100	82	2600 2900	2418 2697	☑️1,2,8,9,11	
					20902	FP28.841/ECO	40	20000	4100	82	2600 2900	2418 2697	☀️☑️1,2,6, 8,9,11	
					20843	FP35.830	40	20000	3000	82	3300 3650	3069 3394	☑️1,2,8,9,11	
					20925	FP35.830/ECO	40	20000	3000	82	3300 3650	3069 3394	☀️☑️1,2,6, 8,9,11	
35	T5	60	57.6	Mini Bipin	20844	FP35.835	40	20000	3500	82	3300 3650	3069 3394	☑️1,2,8,9,11	
					20926	FP35.835/ECO	40	20000	3500	82	3300 3650	3069 3394	☀️☑️1,2,6, 8,9,11	
					20845	FP35.841	40	20000	4100	82	3300 3650	3069 3394	☑️1,2,8,9,11	
					20927	FP35.841/ECO	40	20000	4100	82	3300 3650	3069 3394	☀️☑️1,2,6, 8,9,11	



Commercial Products & Solutions

[SITE SEARCH](#)
[HOME](#)
[PRODUCTS](#)
[EDUCATION / RESOURCES](#)
[LIGHTING APPLICATIONS](#)

[Where to Buy](#) | [FAQs](#) | [Contact Us](#) | [EliteNet](#)

### Compact PAR20 Item Detail

- Home
- Products
- Halogen
  - Retail HIR™ PAR 38
  - HIR/XL (UltraLong Life) PAR38
  - HIR™ PAR38
  - Silver Saver™ PAR38
  - Long Life PAR38
  - Halogen Plus PAR38
  - Standard Halogen PAR38
  - Cool Beam PAR38
  - Quartzline® PAR38
  - Compact HIR™ PAR30
  - Compact PAR30 Long Neck
  - Compact PAR30
  - Compact PAR20
  - Halogen Compact PAR16
  - Diamond Precise™ Electronic MR16
  - PAR36
  - A-Line/Decorative
  - Precise Cover Glass IR MR16



<b>Subcategory</b>	Compact PAR20
<b>Product Code</b>	14927
<b>Description</b>	50PAR20/H/SP10
<b>Volts</b>	120
<b>Watts</b>	50
<b>Average Life in Hours</b>	2500
<b>Lumens</b>	570
<b>CBCP</b>	6000
<b>Color Temperature (K)</b>	2800
<b>Bulb Type</b>	PAR20
<b>Base Type</b>	Med NP
<b>Max Overall Length (in.)</b>	3.125
<b>Max Overall Length (mm)</b>	80
<b>Filament Type</b>	CC-8
<b>Sales Unit UPC</b>	043168906333
<b>Case UPC</b>	043168149273
<b>SCC</b>	00043168149273
<b>Case Quantity</b>	6
<b>Additional information</b>	Spotlight
<b>Footnotes</b>	<p><b>WARNING</b></p> <ul style="list-style-type: none"> <li>- Turn power off before inspection, installation or removal</li> <li>- Keep combustible materials away from lamp</li> <li>- Use in fixture rated for this product—see instructions</li> <li>- Do not use lamp if outer glass is scratched or broken</li> </ul>

## Compact Fluorescent Lamps

PL-C, PL-L, PL-T Lamps



Watts	Bulb	Base	Product Number	Symbols, Footnotes	Ordering Code	Generic Designation	Pkg Qty.	Description	MOL (In.)	Avg. Hrs. Life (230)	Approx. Initial Lumens (231)	Design Lumens (208)	CRI
<b>PL-C Cluster 4-Pin Fluorescent Lamps, Electronic Operation (204)</b>													
13	PL-C	G24q-1	38325-7	\$	PL-C 13W/827/4P/ALTO	CFQ13W/G24q/827	10	2700K	5 3/8	12,000	900	775	82
			38326-5	\$	PL-C 13W/830/4P/ALTO	CFQ13W/G24q/830	10	3000K	5 3/8	12,000	900	775	82
			38327-3	\$	PL-C 13W/835/4P/ALTO	CFQ13W/G24q/835	10	3500K	5 3/8	12,000	900	775	82
			38328-1	\$	PL-C 13W/841/4P/ALTO	CFQ13W/G24q/841	10	4100K	5 3/8	12,000	900	775	82
18	PL-C	G24q-2	38329-9	\$	PL-C 18W/827/4P/ALTO	CFQ18W/G24q/827	10	2700K	5 1/2	12,000	1250	1075	82
			38330-7	\$	PL-C 18W/830/4P/ALTO	CFQ18W/G24q/830	10	3000K	5 1/2	12,000	1250	1075	82
			38332-3	\$	PL-C 18W/835/4P/ALTO	CFQ18W/G24q/835	10	3500K	5 1/2	12,000	1250	1075	82
			38333-1	\$	PL-C 18W/841/4P/ALTO	CFQ18W/G24q/841	10	4100K	5 1/2	12,000	1250	1075	82
26	PL-C	G24q-3	38334-9	\$	PL-C 26W/827/4P/ALTO	CFQ26W/G24q/827	10	2700K	6 1/2	12,000	1800	1550	82
			38335-6	\$	PL-C 26W/830/4P/ALTO	CFQ26W/G24q/830	10	3000K	6 1/2	12,000	1800	1550	82
			38336-4	\$	PL-C 26W/835/4P/ALTO	CFQ26W/G24q/835	10	3500K	6 1/2	12,000	1800	1550	82
			38337-2	\$	PL-C 26W/841/4P/ALTO	CFQ26W/G24q/841	10	4100K	6 1/2	12,000	1800	1550	82
<b>PL-L Long Fluorescent Lamps (204)</b>													
18	PL-L	2G11	34500-9	\$	PL-L 18W/830/4P	FT18W/2G11/830	25	3000K	8 3/8	15,000	1250	1125	82
			35932-3	\$	PL-L 18W/835/4P	FT18W/2G11/835	25	3500K	8 3/8	15,000	1250	1125	82
			34501-7	\$	PL-L 18W/841/4P	FT18W/2G11/841	25	4100K	8 3/8	15,000	1250	1125	82
24	PL-L	2G11	34505-8	\$	PL-L 24W/830/4P	FT24W/2G11/830	25	3000K	12 1/8	15,000	1800	1620	82
			35933-1	\$	PL-L 24W/835/4P	FT24W/2G11/835	25	3500K	12 1/8	15,000	1800	1620	82
			34508-2	\$	PL-L 24W/841/4P	FT24W/2G11/841	25	4100K	12 1/8	15,000	1800	1620	82
36	PL-L	2G11	34511-6	\$	PL-L 36W/830/4P	FT36W/2G11/830	25	3000K	16 3/8	15,000	2900	2610	82
			34942-3	\$	PL-L 36W/835/4P	FT36W/2G11/835	25	3500K	16 3/8	15,000	2900	2610	82
			34513-2	\$	PL-L 36W/841/4P	FT36W/2G11/841	25	4100K	16 3/8	15,000	2900	2610	82
40	PL-L	2G11	30042-6	\$	PL-L 40W/830/4P/RS/IS	FT40W/2G11/RS/830	25	3000K	22 1/2	20,000	3300	2970	82
			30043-4	\$	PL-L 40W/835/4P/RS/IS	FT40W/2G11/RS/835	25	3500K	22 1/2	20,000	3300	2970	82
			30044-2	\$	PL-L 40W/841/4P/RS/IS	FT40W/2G11/RS/841	25	4100K	22 1/2	20,000	3300	2970	82
50	PL-L	2G11	34747-6	\$	PL-L 50W/830/4P/RS	FT50W/2G11/RS/830	25	3000K	22 1/2	20,000	4300	3870	82
			34753-4	\$	PL-L 50W/835/4P/RS	FT50W/2G11/RS/835	25	3500K	22 1/2	20,000	4300	3870	82
			34770-8	\$	PL-L 50W/841/4P/RS	FT50W/2G11/RS/841	25	4100K	22 1/2	20,000	4300	3870	82
55	PL-L	2G11	13844-6	\$	PL-L 55W/950/4P/RS	FT55W/2G11/RS/950	25	5000K	21 1/2	20,000	3650	3358	91
80	PL-L	2G11	38697-9	\$	PL-L 80W/830/4P	FT80W/2G11/830	25	3000K	22 1/2	20,000	6000	5400	82
			38698-7	\$	PL-L 80W/835/4P	FT80W/2G11/835	25	3500K	22 1/2	20,000	6000	5400	82
			38699-5	\$	PL-L 80W/841/4P	FT80W/2G11/841	25	4100K	22 1/2	20,000	6000	5400	82
<b>PL-T Triple 4-Pin Fluorescent Lamps (204)</b>													
18	PL-T	GX24q-2	26802-9	\$	PL-T 18W/827/4P/ALTO	CFTR18W/GX24q/827	12	2700K	4 3/8	12,000	1200	1020	82
			26802-1	\$	PL-T 18W/830/4P/ALTO	CFTR18W/GX24q/830	12	3000K	4 3/8	12,000	1200	1020	82
			26820-1	\$	PL-T 18W/835/4P/ALTO	CFTR18W/GX24q/835	12	3500K	4 3/8	12,000	1200	1020	82
			26822-7	\$	PL-T 18W/841/4P/ALTO	CFTR18W/GX24q/841	12	4100K	4 3/8	12,000	1200	1020	82
26	PL-T	GX24q-3	38440-4	\$	PL-T 26W/827/4P/ALTO	CFTR26W/GX24q/827	12	2700K	5	12,000	1800	1530	82
			26823-5	\$	PL-T 26W/830/4P/ALTO	CFTR26W/GX24q/830	12	3000K	5	12,000	1800	1530	82
			26824-3	\$	PL-T 26W/835/4P/ALTO	CFTR26W/GX24q/835	12	3500K	5	12,000	1800	1530	82
			26825-0	\$	PL-T 26W/841/4P/ALTO	CFTR26W/GX24q/841	12	4100K	5	12,000	1800	1530	82
32	PL-T	GX24q-3	38443-8	\$	PL-T 32W/827/4P/ALTO	CFTR32W/GX24q/827	12	2700K	5 3/8	12,000	2400	2040	82
			26832-6	\$	PL-T 32W/830/4P/ALTO	CFTR32W/GX24q/830	12	3000K	5 3/8	12,000	2400	2040	82
			26833-4	\$	PL-T 32W/835/4P/ALTO	CFTR32W/GX24q/835	12	3500K	5 3/8	12,000	2400	2040	82
			26872-2	\$	PL-T 32W/841/4P/ALTO	CFTR32W/GX24q/841	12	4100K	5 3/8	12,000	2400	2040	82
42	PL-T	GX24q-4	38450-3	\$	PL-T 42W/827/4P/ALTO	CFTR42W/GX24q/827	12	2700K	6 3/8	12,000	3200	2720	82
			26873-0	\$	PL-T 42W/830/4P/ALTO	CFTR42W/GX24q/830	12	3000K	6 3/8	12,000	3200	2720	82
			26875-5	\$	PL-T 42W/835/4P/ALTO	CFTR42W/GX24q/835	12	3500K	6 3/8	12,000	3200	2720	82
			26876-3	\$	PL-T 42W/841/4P/ALTO	CFTR42W/GX24q/841	12	4100K	6 3/8	12,000	3200	2720	82
13487-4	X \$ (242)	PL-T 42W/830/4P/HTA ALTO	CFTR42W/GX24q/830	12	3000K	6 3/8	12,000	3200	2720	82			
13488-2	X \$ (242)	PL-T 42W/835/4P/HTA ALTO	CFTR42W/GX24q/835	12	3500K	6 3/8	12,000	3200	2720	82			
13659-8	X \$ (242)	PL-T 42W/841/4P/HTA ALTO	CFTR42W/GX24q/841	12	4100K	6 3/8	12,000	3200	2720	82			
57	PL-T	GX24q-5	14631-6	\$	PL-T 57W/830/4P/A	CFTR57W/GX24q/830	10	3000K	7 3/8	12,000	4300	3741	82
			14632-4	\$	PL-T 57W/835/4P/A	CFTR57W/GX24q/835	10	3500K	7 3/8	12,000	4300	3741	82
			14633-2	\$	PL-T 57W/841/4P/A	CFTR57W/GX24q/841	10	4100K	7 3/8	12,000	4300	3741	82

**NEW!**

X Orders will be shipped until inventory is depleted; no longer manufactured  
For the most current product information, go to the e-catalog on [www.philips.com](http://www.philips.com)  
Compact Fluorescent symbols and footnotes located on page 87  
This product utilizes ALTO® Lamp Technology



T8 Med Bipin

### OCTRON® AND OCTRON® CURVALUME® FLUORESCENT LAMPS

OCTRON® lamps are T8 fluorescent lamps designed to be operated on dedicated magnetic rapid start or electronic instant start, rapid start or programmed rapid start (also known as programmed start) ballasts. OCTRON lamps may be operated on electronic instant start ballasts with ballast factors ranging from .71 to 1.20 at the nominal ballast input voltage. For details on various lamp/ballast system combinations, please refer to the Systems Performance Guide in the "SYLVANIA QUICKTRONIC® Ballast Technology & Specification Guide".

#### OCTRON® 800, 800 XP™ and 800 XPS® Lamps

Nominal Wattage	Bulb	Nominal Length (in)	MOL (in)	Base	Product Number	Ordering Abbreviation	Pkg Qty	Avg Rated Life (hrs)	CCT (K)	CRI	Approx Lumens Initial Mean		Symbols & Footnotes
											@25°C/77°F	@25°C/77°F	
17	T8	24	23.78	Med Bipin	22137	F017/841/ECO	30	20000	4100	82	1350	1240	☀️☀️ 1,2,6,8,20,21
					21907	F017/841/XP/ECO	30	24000	4100	85	1375	1305	☀️☀️ 1,2,6,8,21,22,23
					22152	F017/841/XPS/ECO	30	30000	4100	85	1400	1340	☀️☀️ 1,2,6,8,21,28,31
25	T8	36	35.78	Med Bipin	22138	F025/830/ECO	30	20000	3000	82	2150	1975	☀️☀️ 1,2,6,8,20,21
					21910	F025/830/XP/ECO	30	24000	3000	85	2175	2065	☀️☀️ 1,2,6,8,21,22,23
					22153	F025/830/XPS/ECO	30	30000	3000	85	2200	2090	☀️☀️ 1,2,6,8,21,28,31
					22139	F025/835/ECO	30	20000	3500	82	2150	1975	☀️☀️ 1,2,6,8,20,21
					21776	F025/835/XP/ECO	30	24000	3500	85	2175	2065	☀️☀️ 1,2,6,8,21,22,23
					22154	F025/835/XPS/ECO	30	30000	3500	85	2200	2090	☀️☀️ 1,2,6,8,21,28,31
					22140	F025/841/ECO	30	20000	4100	82	2150	1975	☀️☀️ 1,2,6,8,20,21
					21774	F025/841/XP/ECO	30	24000	4100	85	2175	2065	☀️☀️ 1,2,6,8,21,22,23
					22155	F025/841/XPS/ECO	30	30000	4100	85	2200	2090	☀️☀️ 1,2,6,8,21,28,31
28	T8	48	47.78	Med Bipin	22177	F028/830/XP/SS/ECO	30	18000	3000	82	2725	2560	☀️☀️ 1,2,6,22,23,29,30
					22178	F028/835/XP/SS/ECO	30	18000	3500	82	2725	2560	☀️☀️ 1,2,6,22,23,29,30
					22179	F028/841/XP/SS/ECO	30	18000	4100	82	2725	2560	☀️☀️ 1,2,6,22,23,29,30
30	T8	48	47.78	Med Bipin	22063	F030/830/XP/SS/ECO	30	18000	3000	82	2850	2680	☀️☀️ 1,2,6,22,23,29,30
					22060	F030/835/XP/SS/ECO	30	18000	3500	82	2850	2680	☀️☀️ 1,2,6,22,23,29,30
					22062	F030/841/XP/SS/ECO	30	18000	4100	82	2850	2680	☀️☀️ 1,2,6,22,23,29,30
32	T8	48	47.78	Med Bipin	22039	F032/827/XP/ECO	30	24000	2700	84	3000	2850	☀️☀️ 1,2,6,8,21,22,23
					21777	F032/830/ECO	30	20000	3000	82	2950	2710	☀️☀️ 1,2,6,8,20,21
					21759	F032/830/XP/ECO	30	24000	3000	85	3000	2850	☀️☀️ 1,2,6,8,21,22,23
					21680	F032/830/XPS/ECO	30	30000	3000	85	3100	2945	☀️☀️ 1,2,6,8,14,21,28,31
					21779	F032/835/ECO	30	20000	3500	82	2950	2710	☀️☀️ 1,2,6,8,20,21

For more complete product information visit [www.sylvania.com](http://www.sylvania.com)  
116

Symbols/Footnotes on page 139-143



- Catalog
- Lighting Solutions
- Breakthrough Products
- TradeLink<sup>SM</sup>
- Lighting Application Center
- Browse Literature
- Environment & Sustainability

## MasterColor CDM 100W/830 Med ED17 CO ALTO



Keyword search  

[+ Advanced search](#)

MasterColor CDM 100W/830 Med ED17 CO ALTO

### Lamp Description

Range of high-efficiency long life ceramic metal halide lamps with a stable color over life time and a crisp, sparkling light.

- [Download product data sheet](#)
- [Print page](#)

Product specs:		<a href="#">+ Images:</a>	<a href="#">+ Family info:</a>
<a href="#">Warning/Caution notice</a>			
<a href="#">MSDS sheets</a>			
<b>PRODUCT DATA</b>			
Product Number	208892		
Full product name	MasterColor CDM 100W/830 Med ED17 CO ALTO		
Ordering Code	MHC100/C/U/M/3K ALTO		
Pack type	1 Sleeve Open End		
Pieces per Sku	1		
Skus/Case	12		
Pack UPC	046677208899		
EAN2US			
Case Bar Code	50046677208894		
Successor Product number			
<b>General Characteristics</b>			
Base	Medium (Single Contact Medium Screw)		
Base Information	Brass (Brass Base)		
Bulb	ED17		
Bulb Material	Hard Glass		
Bulb Finish	Coated		
Operating Position	Universal (Any or Universal (U))		
Packing Type	1SL (1 Sleeve Open End)		
Packing Configuration	12		
RatedAvgLife(See Family Notes)	16000 hr		
Feature	ALTO®		
Ordering Code	MHC100/C/U/M/3K ALTO		
Pack UPC	046677208899		
Case Bar Code	50046677208894		
ANSI Code HID	M140/M90/E		
<b>Electrical Characteristics</b>			
Watts	100W		
Lamp Voltage	100 V		
<b>Environmental Characteristics</b>			
Mercury (Hg) Content	6.4 mg		
<b>Light Technical Characteristics</b>			
Color Code	830 (CCT of 3000K)		
Color Rendering Index	85 Ra8		
Color Designation	Warm White		
Color Temperature	3000 K		
Initial Lumens	8800 Lm		
Design Mean Lumens	6600 Lm		
<b>Product Dimensions</b>			
Light Center Length L	3.438 in		
Max Overall Length (MOL) - C	5.438 in		
Diameter D	2.125 in		
<b>Logistic and Packing Data</b>			
Product Number	208892		



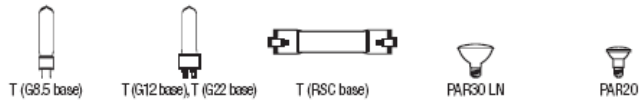

### POWERBALL® CERAMIC METALARC® TUBULAR SINGLE-ENDED High CRI, Pulse Start, UV Stop – Enclosed Fixtures Only

Watts	Bulb	Base	Product Number	Ordering Abbreviation	ANSI Code	Pkg Qty	Lamp Finish	Operating Position	Fix Req	Avg Rated Life (hrs)	Approx Lumens (initial)	Approx Lumens (mean)	CRI	CCT (K)	Symbols & Footnotes
20	T4.5	G8.5	64882	MC20TC/U/G8.5/830PB	M156/E	12	Clear	Universal	E	12000	1700	1275	83	3000	☀️☀️☀️ I,4,18,24,25,30,48
39	T4.5	G8.5	64791	MC39TC/U/G8.5/830PB	M130/E	12	Clear	Universal	E	12000	3400	2720	82	3000	☀️☀️☀️ I,4,18,24,25,30,48
	T6	G12	64363	MC39T6/U/G12/830PB	M130/E	12	Clear	Universal	E	12000	3400	2720	82	3000	☀️☀️☀️ I,4,18,24,25,30,48
			64325	MC39T6/U/G12/940PB	M130/E	12	Clear	Universal	E	12000	3300	2640	90	4200	☀️☀️☀️ I,4,18,24,25,26,30,48
70	T4.5	G8.5	64825	MC70TC/U/G8.5/830PB	M139/E, M98/E	12	Clear	Universal	E	12000	6300	5040	95	3000	☀️☀️☀️ I,4,18,24,25,26,30,48
	T6	G12	64361	MC70T6/U/G12/830PB	M139/E, M98/E	12	Clear	Universal	E	12000	7000	5600	87	3000	☀️☀️☀️ I,4,18,24,25,26,30,48
			64200	MC70T6/U/G12/930PB	M139/E, M98/E	12	Clear	Universal	E	12000	6400	5120	95	3000	☀️☀️☀️ I,4,18,24,25,26,30,48
			64338	MC70T6/U/G12/940PB	M139/E, M98/E	12	Clear	Universal	E	12000	6700	5360	93	4200	☀️☀️☀️ I,4,18,24,25,26,30,48
150	T7.5	G12	64359	MC150T7.5/U/G12/830	M102/E, M142/E	12	Clear	Universal	E	12000	15500	12400	89	3000	☀️☀️☀️ I,4,18,24,30,31,48
			64337	MC150T7.5/U/G12/940PB	M102/E, M142/E	12	Clear	Universal	E	12000	14500	11600	95	4200	☀️☀️☀️ I,4,18,24,30,31,48
250	T9	G22	64167	MC250T9/U/G22/830PB	M80/E	10	Clear	Universal	E	12000	24500	19600	86	3000	☀️☀️☀️ I,4,18,24,30,31,48

### POWERBALL® CERAMIC METALARC® TUBULAR DOUBLE-ENDED

Watts	Bulb	Base	Product Number	Ordering Abbreviation	ANSI Code	Pkg Qty	Lamp Finish	Operating Position	Fix Req	Avg Rated Life (hrs)	Approx Lumens (initial)	Approx Lumens (mean)	CRI	CCT (K)	Symbols & Footnotes
70	T6	RX7s RSC	64793	MC70T6/DE/830PB	M139/E, M85/E, M98/E	12	Clear	HOR ± 45°	E	12000	6900	5520	88	3000	☀️☀️☀️ I,4,18,25,26,30,35,48
150	T7.5	RX7s RSC	64794	MC150T7.5/DE/830PB	M102/E, M142/E, M81/E	12	Clear	HOR ± 45°	E	12000	14800	11840	91	3000	☀️☀️☀️ I,4,18,30,37,48

### POWERBALL® CERAMIC METALARC® PAR High CRI, Pulse Start, UV Stop – Open or Enclosed Fixtures

Watts	Bulb	Base	Product Number	Ordering Abbreviation	ANSI Code	Pkg Qty	Beam Type	Beam Angle	Operating Position	Fix Req	Avg Rated Life (hrs)	Approx Lumens (initial)	Approx Lumens (mean)	CRI	CCT (K)	Symbols & Footnotes
20	PAR30LN	E26 Med	64879	MCP20PAR30LN/U/830/SP/ECOPB	M156/0	6	SP	10°	Universal	O	12000	24000	1200	82	3100	☀️☀️☀️ I,4,7,17,24,30,48
			64878	MCP20PAR30LN/U/830/FL/ECOPB	M156/0	6	FL	30°	Universal	O	12000	4000	1200	82	3100	☀️☀️☀️ I,4,7,17,24,30,48
39	PAR20	E26 Med	64824	MCP39PAR20/U/830/SPPB	M130/0	12	SP	10°	Universal	O	12000	20000	2000	87	3000	☀️☀️☀️ I,4,17,24,25,30,48
			64826	MCP39PAR20/U/830/FLPB	M130/0	12	FL	30°	Universal	O	12000	5000	2000	87	3000	☀️☀️☀️ I,4,17,24,25,30,48
	PAR30LN	E26 Med	64880	MCP39PAR30LN/U/830/SP/ECOPB	M130/0	6	SP	10°	Universal	O	12000	39600	2300	85	3000	☀️☀️☀️ I,4,7,17,24,25,30,48
			64881	MCP39PAR30LN/U/830/FL/ECOPB	M130/0	6	FL	30°	Universal	O	12000	8000	2300	85	3000	☀️☀️☀️ I,4,7,17,24,25,30,48

For more complete product information visit [www.sylvania.com](http://www.sylvania.com)

Symbols/Footnotes on page 101-102



TUNGSTEN HALOGEN

### DOUBLE END QUARTZ LAMPS

A suitable protective shield, screening technique or both shall be used to protect people and surroundings from the possibility of a lamp shattering and from possible ultraviolet radiation.

Watts	Bulb	Base	Product Number	Symbols & Footnotes	Ordering Abbreviation	Volts	Pkg Qty	Lamp Finish	Class & Filament	Avg Rated Life(hrs)	Lumens CCT	LCL (in)	MOL (in)
300	T3	RSC	58920	123,139	300T3QCLAP(EHM)	120	6	Clear	C,C-8	2000	6000 2950		4.69
			58000	123,139	300T3QCL	130	20	Clear	C,C-8	2000	6000 2950		4.69
500	T3	RSC	58996	123,139	500T3QCL(FCL)	120	20	Clear	C,C-8	2000	8750 2950		4.69
			58865	123,139	500T3QCLAP(FCL)	120	6	Clear	C,C-8	2000	8750 2950		4.69
			58997	123,139	500T3QCL	130	20	Clear	C,C-8	2000	8750 2950		4.69
1000	T3	RSC	58948	123,139	1000T3QCL	240	12	Clear	C,C-8	2000	21500 2950		10.06
1500	T3	RSC	58859	123,139	1500T3QCL	208	12	Clear	C,C-8	2000	33000 2950		10.06
			58857	123,139	1500T3QCL	240	12	Clear	C,C-8	2000	33000 2950		10.06
			58858	123,139	1500T3QCL	277	12	Clear	C,C-8	2000	33000 2950		10.06

### OSRAM MINISTAR LAMPS

Suitable for use in unshielded fixtures. Consult most recent luminaire standards for your area to determine luminaire requirements.

Watts	Bulb	Base	Product Number	Symbols & Footnotes	Ordering Abbreviation	Volts	Pkg Qty	Beam Type	Class & Filament	Avg Rated Life(hrs)	Lumens CCT	CBCP	Beam Angle	MOL (in)	
10	T3	G4 Bipin	58520	72,84,123,145	10T3QMINISTARS	12	40	FL	C,C-8	2000	3000	80	35 x 60	1.31	
20	T3	G4 Bipin	58521	72,84,123,145	20T3QMINISTARS	12	40	FL	C,C-8	2000	3000	120	35 x 60	1.31	
		BT4	GY6.35 Bipin	58518	72,84,123,145	20BT4QMINISTARAX	12	40	FL	C,C-8	2000	3000	800	20	1.75
35	BT4	GY6.35 Bipin	58519	72,84,123,145	35BT4QMINISTARAX	12	40	FL	C,C-8	2000	3000	1000	30	1.75	

### BI-PIN IR LAMPS

UV Filter capsule with axial filament and infrared reflective coating. Suitable for use in unshielded fixtures. Consult most recent luminaire standards for your area to determine luminaire requirements.

Watts	Bulb	Base	Product Number	Symbols & Footnotes	Ordering Abbreviation	Volts	Pkg Qty	Lamp Finish	Class & Filament	Avg Rated Life(hrs)	Lumens CCT	LCL (in)	MOL (in)
25	BT4	GY6.35 Bipin	58897	145	25BT4Q/IR	12	40	Clear	C,AXIAL	4000	450 3000	1.13	1.75
35	BT4	GY6.35 Bipin	58896	145	35BT4Q/IR	12	40	Clear	C,AXIAL	4000	800 3000	1.13	1.75

For more complete product information visit [www.sylvania.com](http://www.sylvania.com)

Symbols/Footnotes on page 54-68



Commercial Products & Solutions

[SITE SEARCH](#)   [HOME](#)   [PRODUCTS](#)   [EDUCATION / RESOURCES](#)   [LIGHTING APPLICATIONS](#)

[Where to Buy](#) | [FAQs](#) | [Contact Us](#) | [EliteNet](#)

[Products](#) > [Halogen](#) > [PAR](#) > [PAR20](#) > 17868

**17868 – 50PAR20/H/FL25**

GE PAR20



• Standard Halogen - Crisp, white light

Energy Savings

**GENERAL CHARACTERISTICS**

Lamp type	Halogen - PAR
Bulb	PAR20
Base	Medium NP
Filament	CC-8
Wattage	50/46
Voltage	130/120
Rated Life	3000 hrs/6000 hrs



[View Larger](#)

**PHOTOMETRIC CHARACTERISTICS**

Initial Lumens	570/498
Center Beam Candlepower (CBCP)	1500
Color Temperature	2800 K
Nominal Initial Lumens per Watt	11

**DIMENSIONS**

Maximum Overall Length (MOL)	3 1/8
Bulb Diameter (DIA)	2 1/2

**PRODUCT INFORMATION**

Product Code	17868
Description	50PAR20/H/FL25
Standard Package	Case
Standard Package GTIN	00043168178686
Standard Package Quantity	15
Sales Unit	Unit
No Of Items Per Sales Unit	1
No Of Items Per Standard Package	15
UPC	043168970112

**ADDITIONAL RESOURCES**

[Catalogs](#)

[Testimonials](#)

**Brochures**

- Product Brochures
  - [Halogen Lamps](#)

[IES/Photometric Download](#)

[MSDS \(Material Safety Data Sheets\)](#)

[Disposal Policies & Recycling Information](#)

**CAUTIONS & WARNINGS**

[See list of cautions & warnings.](#)



Commercial Products & Solutions

[SITE SEARCH](#) > [HOME](#) > [PRODUCTS](#) > [EDUCATION / RESOURCES](#) > [LIGHTING APPLICATIONS](#)

[Where to Buy](#) | [FAQs](#) | [Contact Us](#) | [EliteNet](#)

[Products](#) > [Halogen](#) > [PAR](#) > [PAR30](#) > 14022

### 14022 – 50PAR30/H/FL35

GE Edison™ PAR30



- Edison™ halogen bulbs provide a brighter, crisper light that makes your home look its best
- That's why professionals choose Edison for exceptional results and longer bulb life.
- Showcase the beauty of your home with the highest quality of light.

#### Energy Savings



[View Larger](#)

#### GENERAL CHARACTERISTICS

Lamp type	Halogen - PAR
Bulb	PAR30
Base	Medium NP
Filament	CC-8
Wattage	50
Voltage	120
Rated Life	3000 hrs
Primary Application	Indoor Floodlight

#### PHOTOMETRIC CHARACTERISTICS

Initial Lumens	630
Center Beam Candlepower (CBCP)	1400
Color Temperature	2800 K
Nominal Initial Lumens per Watt	12

#### DIMENSIONS

Maximum Overall Length (MOL)	3.6200 in (91.9 mm)
Bulb Diameter (DIA)	3.750 in (95.2 mm)

#### PRODUCT INFORMATION

Product Code	14022
Description	50PAR30/H/FL35
Standard Package	Case
Standard Package GTIN	10043168140222
Standard Package Quantity	6
Sales Unit	Unit
No Of Items Per Sales Unit	1
No Of Items Per Standard Package	6
UPC	043168140225

#### CAUTIONS & WARNINGS

#### ADDITIONAL RESOURCES

[Catalogs](#)

[Testimonials](#)

#### Brochures

- Product Brochures
  - [Halogen Lamps](#)
  - [Industrial Lighting](#)
- Application/Segment Brochures
  - [Healthcare Lighting](#)
  - [Office Lighting](#)
  - [Retail Lighting](#)

[IES/Photometric Download](#)

[MSDS \(Material Safety Data Sheets\)](#)

[Disposal Policies & Recycling Information](#)

# Ballast Cut Sheets

QUICKTRONIC® PROFESSIONAL DALI DIMMING SYSTEMS - 100-1% Dimming Range - <10% THD - For a list of DALI controllers, contact OSRAM SYLVANIA

Item Number	OSRAM SYLVANIA Description	Input Voltage (VAC)	Input Current (AMPS)	Lamp Type	Rated Lumens (lm)	No. of Lamps	Ballast Factor (BF)	System Lumens	Input Wattage (W)	System Efficacy (lm/W)
<b>QUICKTRONIC® PROFESSIONAL DALI DIMMING SYSTEMS - 100-1% Dimming Range - &lt;10% THD - For a list of DALI controllers, contact OSRAM SYLVANIA</b>										
<b>T8</b>										
51350	QTP 1x32T8/UNV DALI	120-277	0.31/0.13	F032XP	3000	1	1.00 0.01	3000 30	36 6	83
51352	QTP 2x32T8/UNV DALI	120-277	0.61/0.25	F032XP	3000	2	1.00 0.01	6000 60	72/70 12	83/85
<i>DALI QTP models above also operate these lamps: F8032</i>										
<b>T5HO</b>										
51364	QTP 1x54T5HO/UNV DALI	120-277	0.52/0.22	FF54HO	5000	1	1.00 0.01	5000 50	62/61 9	81/82
51366	QTP 2x54T5HO/UNV DALI	120-277	1.05/0.44	FF54HO	5000	2	1.00 0.01	10,000 100	122/119 18	82/84
<b>T5</b>										
51356	QTP 1x28T5/UNV DALI	120-277	0.27/0.11	FP28	2900	1	1.00 0.01	2900 29	32 6	91
51358	QTP 2x28T5/UNV DALI	120-277	0.55/0.23	FP28	2900	2	1.00 0.01	5800 58	64/62 12	91/94
51357	QTP 1x14T5/UNV DALI	120-277	0.15/0.07	FP14	1350	1	1.00 0.01	1350 14	18	75
51359	QTP 2x14T5/UNV DALI	120-277	0.29/0.13	FP14	1350	2	1.00 0.01	2700 27	34/33	79/82
51360	QTP 1x35T5/UNV DALI	120-277	0.34/0.14	FP35	3650	1	1.00 0.01	3650 37	40/39	91/94
51361	QTP 2x35T5/UNV DALI	120-277	0.67/0.28	FP35	3650	2	1.00 0.01	7300 73	79/76	92/95
<b>QUICKTRONIC® PROFESSIONAL DALI COMPACT FLUORESCENT DIMMING SYSTEMS - For a list of DALI controllers, contact OSRAM SYLVANIA</b>										
<b>T4 and T5 DALI - 100-3% Dimming Range - &lt;10% THD</b>										
51370	QTP 1x18CF/UNV DALI	120-277	0.16/0.08	18W DD/E, T/E	1200	1	1.00 0.03	1200 35	20	60
51372	QTP 2x18CF/UNV DALI	120-277	0.33/0.14	18W DD/E, T/E	1200	2	1.00 0.03	2400 70	39/38	61/63
51375	QTP 1x26CF/UNV DALI	120-277	0.24/0.10	26W DD/E, T/E	1800	1	1.00 0.03	1800 55	28	64
51377	QTP 2x26CF/UNV DALI	120-277	0.49/0.22	26W DD/E, T/E	1800	2	1.00 0.03	3600 110	55/54	65/67
51380	QTP 1x32CF/UNV DALI	120-277	0.34/0.15	32W DT/E	2400	1	1.00 0.03	2400 70	38	63
51382	QTP 2x32CF/UNV DALI	120-277	0.60/0.25	32W DT/E	2400	2	1.00 0.03	4800 140	71/70	68/69
51384	QTP 1x42CF/UNV DALI	120-277	0.45/0.19	42W DT/E	3200	1	1.00 0.03	3200 95	49	65
51386	QTP 2x42CF/UNV DALI	120-277	0.82/0.35	42W DT/E	3200	2	1.00 0.03	6400 190	92/91	69/70
51390	QTP 1x40TT5/UNV DALI	120-277	0.41/0.17	40W DL	3150	1	1.00 0.03	3150 95	45/44	70/72
51392	QTP 2x40TT5/UNV DALI	120-277	0.83/0.37	40W DL	3150	2	1.00 0.03	6300 190	97/94	85/67
<b>QUICKTRONIC® 96IS &amp; 96HO</b>										
<b>F96T12 Instant Start - Normal Ballast Factor- &lt;20% THD</b>										
49881	QT 2x96/120 IS	120	1.12	F96SS F96	5300 6420	2	0.85	9010 10910	107 132	84 83
49882	QT 2x96/277 IS	277	0.49	F96SS F96	5300 6420	2	0.85	9010 10910	107 132	84 83
<i>QT IS models above also operate these lamps: F84T12, F72T12 &amp; F60T12</i>										
<b>F96T12 High Output- Normal Ballast Factor- ~20% THD</b>										
49883	QT 2x96/120 HO	120	1.74	F96HOSS F96HC	8000 9050	2	0.89	14240 16109	170 205	84 79
49884	QT 2x96/277 HO	277	0.76	F96HOSS F96HC	8000 9050	2	0.85	13600 15365	170 205	80 75
<i>QT HO models above also operate these lamps: F84T12/HO, F72T12/HO, F60T12/HO, &amp; F48T12/HO</i>										

OSRAM SYLVANIA National Customer Service and Sales Center  
1-800-LIGHTBULB (1-800-544-4828) or www.sylvania.com

© New Product. Contact OSRAM SYLVANIA for product availability.



<b>ICN-2S28@120</b>	
Brand Name	CENTIUM T5
Ballast Type	Electronic
Starting Method	Programmed Start
Lamp Connection	Series
Input Voltage	120
Input Frequency	50/60 HZ
Status	Active

**Electrical Specifications**

Lamp Type	Num. of Lamps	Rated Lamp Watts	Min. Start Temp (*F/C)	Input Current (Amps)	Input Power (ANSI Watts)	Ballast Factor	MAX THD %	Power Factor	MAX Lamp Current Crest Factor	B.E.F.
F14T5	1	14	0/-18	0.16	19	1.07	20	0.98	1.7	5.63
F14T5	2	14	0/-18	0.29	34	1.06	10	0.98	1.7	3.12
F21T5	1	21	0/-18	0.21	26	1.03	15	0.99	1.7	3.96
F21T5	2	21	0/-18	0.40	48	1.02	10	0.98	1.7	2.13
* F28T5	1	28	0/-18	0.28	33	1.04	10	0.98	1.7	3.15
F28T5	2	28	0/-18	0.55	64	1.03	10	0.99	1.7	1.61
F35T5	1	35	0/-18	0.34	41	1.01	10	0.98	1.7	2.46
F35T5	2	35	0/-18	0.67	80	1.00	10	0.99	1.7	1.25

**Wiring Diagram**

The wiring diagram that appears above is for the lamp type denoted by the asterisk (\*)

**Standard Lead Length (inches)**

	in.	cm.
Black	0	0
White	0	0
Blue	0	0
Red	0	0
Yellow	0	0
Gray	0	0
Violet	0	0

	in.	cm.
Yellow/Blue	0	0
Blue/White	0	0
Brown	0	0
Orange	0	0
Orange/Black	0	0
Black/White	0	0
Red/White	0	0

**Enclosure**

**Enclosure Dimensions**

OverAll (L)	Width (W)	Height (H)	Mounting (M)
16.70 "	1.18 "	1.00 "	16.34 "
16 7/10	1 9/50	1	16 17/50
42.4 cm	3 cm	2.5 cm	41.5 cm

Revised 08/21/2006



Data is based upon tests performed by Advance Transformer in a controlled environment and representative of relative performance. Actual performance can vary depending on operating conditions. Specifications are subject to change without notice. All specifications are nominal unless otherwise noted.

**ADVANCE**  
O'HARE INTERNATIONAL CENTER · 10275 WEST HIGGINS ROAD · ROSEMONT, IL 60018  
Customer Support/Technical Service: Phone: 800-372-3331 · Fax: 630-307-3071  
Corporate Offices: Phone: 800-322-2086





<b>RCF-2S26-H1-LD-QS</b>	
Brand Name	AMBISTAR - HPF
Ballast Type	Electronic
Starting Method	Rapid Start
Lamp Connection	Series
Input Voltage	120
Input Frequency	60
Status	Active

**Electrical Specifications**

Lamp Type	Num. of Lamps	Rated Lamp Watts	Min. Start Temp (*F/C)	Input Current (Amps)	Input Power (ANSI Watts)	Ballast Factor	MAX THD %	Power Factor	MAX Lamp Current Crest Factor	B.E.F.
CFQ26W/G24Q	1	26	0/-18	0.23	27	1.00	10	0.98	1.7	3.70
CFQ26W/G24Q	2	26	0/-18	0.43	51	1.00	10	0.98	1.7	1.96
CFTR26W/GX24Q	1	26	0/-18	0.24	29	1.10	10	0.98	1.7	3.79
CFTR26W/GX24Q	2	26	0/-18	0.45	54	1.00	10	0.98	1.7	1.85
*CFTR32W/GX24Q	1	32	0/-18	0.31	36	0.98	10	0.98	1.7	2.72
CFTR42W/GX24Q	1	42	0/-18	0.38	46	0.98	10	0.98	1.7	2.13

**Wiring Diagram**

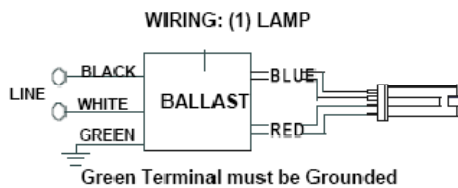

The wiring diagram that appears above is for the lamp type denoted by the asterisk (\*)

**Standard Lead Length (inches)**

	in.	cm.		in.	cm.
Black	0	0	Yellow/Blue		0
White	0	0	Blue/White		0
Blue	0	0	Brown		0
Red	0	0	Orange		0
Yellow	0	0	Orange/Black		0
Gray		0	Black/White		0
Violet		0	Red/White		0

**Enclosure**

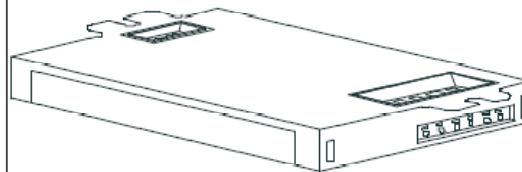

**Enclosure Dimensions**

OverAll (L)	Width (W)	Height (H)	Mounting (M)
4.98 "	2.4 "	1.0 "	4.6 "
4 49/50	2 2/5	1	4 3/5
12.6 cm	6.1 cm	2.5 cm	11.7 cm

Revised 09/10/2007



Data is based upon tests performed by Advance Transformer in a controlled environment and representative of relative performance. Actual performance can vary depending on operating conditions. Specifications are subject to change without notice. All specifications are nominal unless otherwise noted.

**ADVANCE**

O'HARE INTERNATIONAL CENTER · 10275 WEST HIGGINS ROAD · ROSEMONT, IL 60018  
Customer Support/Technical Service: Phone: 800-372-3331 · Fax: 630-307-3071  
Corporate Offices: Phone: 800-322-2086



<b>REL-1P32-LW-SC</b>	
Brand Name	STANDARD ELEC
Ballast Type	Electronic
Starting Method	Instant Start
Lamp Connection	Parallel
Input Voltage	120
Input Frequency	60 HZ
Status	Active

**Electrical Specifications**

Lamp Type	Num. of Lamps	Rated Lamp Watts	Min. Start Temp (°F/C)	Input Current (Amps)	Input Power (ANSI Watts)	Ballast Factor	MAX THD %	Power Factor	MAX Lamp Current Crest Factor	B.E.F.
F17T8	1	17	0/-18	0.17	18	0.87	25	0.90	1.7	4.83
F25T8	1	25	0/-18	0.21	24	0.82	20	0.95	1.7	3.42
* F32T8	1	32	0/ -18	0.24	29	0.75	20	0.98	1.7	2.59
F32T8/ES (30W)	1	30	60/16	0.23	27	0.75	20	0.98	1.7	2.78

**Wiring Diagram**

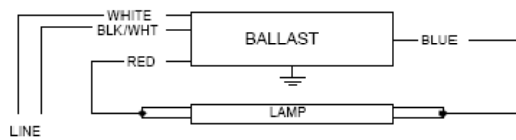

Diag. 63

The wiring diagram that appears above is for the lamp type denoted by the asterisk (\*)

**Standard Lead Length (inches)**

	in.	cm.
Black		
White	25.0	
Blue	31.0	
Red	37.0	
Yellow		
Gray		
Violet		

	in.	cm.
Yellow/Blue		
Blue/White		
Brown		
Orange		
Orange/Black		
Black/White	25.0	
Red/White		

**Enclosure**

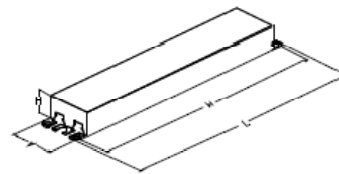

**Enclosure Dimensions**

OverAll (L)	Width (W)	Height (H)	Mounting (M)
9.50 "	1.7 "	1.18 "	8.90 "
9 1/2	1 7/10	1 9/50	8 9/10
24.1 cm	4.3 cm	3 cm	22.6 cm



Revised 08/26/2002



Data is based upon tests performed by Advance Transformer in a controlled environment and representative of relative performance. Actual performance can vary depending on operating conditions. Specifications are subject to change without notice. All specifications are nominal unless otherwise noted.

**ADVANCE**

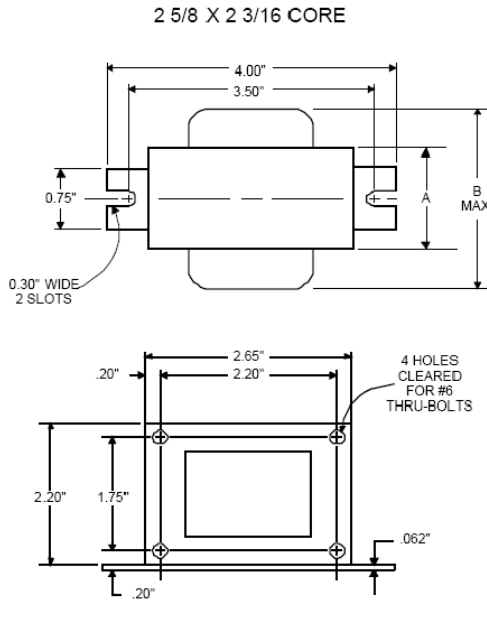

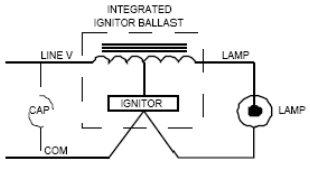

O'HARE INTERNATIONAL CENTER · 10275 WEST HIGGINS ROAD · ROSEMONT, IL 60018  
Customer Support/Technical Service: Phone: 800-372-3331 · Fax: 630-307-3071  
Corporate Offices: Phone: 800-322-2086

	<b>Metal Halide Lamp Ballast</b>	<b>Catalog Number 71A5337BP</b> <b>For 100W M90/M140</b> <b>60 Hz R-HPF</b> <b>Status: Active</b>																																																																																																																																																																																				
<b>DIMENSIONS AND DATA</b>																																																																																																																																																																																						
 <p><b>2 5/8 X 2 3/16 CORE</b></p> <p>0.75" 0.30" WIDE 2 SLOTS</p> <p>4.00" 3.50"</p> <p>0.75" A B MAX.</p> <p>2.65" 2.20"</p> <p>4 HOLES CLEARED FOR #6 THRU-BOLTS</p> <p>2.20" 1.75"</p> <p>.20"</p> <p>.062"</p>	<table border="1"> <tr> <td>INPUT VOLTS</td> <td>277</td> <td></td> <td></td> <td></td> </tr> <tr> <td>CIRCUIT TYPE</td> <td>R-HPF</td> <td></td> <td></td> <td></td> </tr> <tr> <td>POWER FACTOR (min)</td> <td>90%</td> <td></td> <td></td> <td></td> </tr> <tr> <td>REGULATION</td> <td></td> <td></td> <td></td> <td></td> </tr> <tr> <td>Line Volts</td> <td>±5%</td> <td></td> <td></td> <td></td> </tr> <tr> <td>Lamp Watts</td> <td>±10%</td> <td></td> <td></td> <td></td> </tr> <tr> <td>LINE CURRENT (Amps)</td> <td></td> <td></td> <td></td> <td></td> </tr> <tr> <td>Operating.....</td> <td>0.45</td> <td></td> <td></td> <td></td> </tr> <tr> <td>Open Circuit.....</td> <td>1.05</td> <td></td> <td></td> <td></td> </tr> <tr> <td>Starting.....</td> <td>0.70</td> <td></td> <td></td> <td></td> </tr> <tr> <td>UL TEMPERATURE RATINGS</td> <td></td> <td></td> <td></td> <td></td> </tr> <tr> <td>Insulation Class</td> <td>H(180°C)</td> <td></td> <td></td> <td></td> </tr> <tr> <td>Coil Temperature Code</td> <td>1029</td> <td>A</td> <td></td> <td></td> </tr> <tr> <td>MIN. AMBIENT STARTING TEMP.</td> <td>-20°F or -30°C</td> <td></td> <td></td> <td></td> </tr> <tr> <td>NOM. OPEN CIRCUIT VOLTAGE</td> <td>277</td> <td></td> <td></td> <td></td> </tr> <tr> <td>INPUT VOLTAGE AT LAMP DROPOUT.....</td> <td>190</td> <td></td> <td></td> <td></td> </tr> <tr> <td>INPUT WATTS</td> <td>118</td> <td></td> <td></td> <td></td> </tr> <tr> <td>RECOMMENDED FUSE (Amps).....</td> <td>3</td> <td></td> <td></td> <td></td> </tr> <tr> <td>CORE and COIL</td> <td></td> <td></td> <td></td> <td></td> </tr> <tr> <td>Dimension (A)</td> <td>1.80</td> <td></td> <td></td> <td></td> </tr> <tr> <td>Dimension (B)</td> <td>3.10</td> <td></td> <td></td> <td></td> </tr> <tr> <td>Weight (lbs.)</td> <td>3.2</td> <td></td> <td></td> <td></td> </tr> <tr> <td>Lead Lengths</td> <td>12"</td> <td></td> <td></td> <td></td> </tr> <tr> <td>CAPACITOR REQUIREMENT</td> <td></td> <td></td> <td></td> <td></td> </tr> <tr> <td>Microfarads</td> <td>10.0</td> <td></td> <td></td> <td></td> </tr> <tr> <td>Volts (min.)</td> <td>280</td> <td></td> <td></td> <td></td> </tr> <tr> <td>Fault Current Withstand (amps)</td> <td></td> <td></td> <td></td> <td></td> </tr> <tr> <td>60 Hz TEST PROCEDURES (Refer to Advance Test Procedure for HID Ballasts - Form 1270)</td> <td></td> <td></td> <td></td> <td></td> </tr> <tr> <td>High Potential Test (Volts)</td> <td></td> <td></td> <td></td> <td></td> </tr> <tr> <td>1 minute</td> <td>2000</td> <td></td> <td></td> <td></td> </tr> <tr> <td>2 seconds</td> <td>2500</td> <td></td> <td></td> <td></td> </tr> <tr> <td>Open Circuit Voltage Test (Volts)</td> <td>260-290</td> <td></td> <td></td> <td></td> </tr> <tr> <td>Short-Circuit Current Test (Amps)</td> <td></td> <td></td> <td></td> <td></td> </tr> <tr> <td>Secondary Current</td> <td>1.05-1.55</td> <td></td> <td></td> <td></td> </tr> <tr> <td>Input Current.....</td> <td>0.25</td> <td></td> <td></td> <td></td> </tr> <tr> <td></td> <td>0.35</td> <td></td> <td></td> <td></td> </tr> </table>	INPUT VOLTS	277				CIRCUIT TYPE	R-HPF				POWER FACTOR (min)	90%				REGULATION					Line Volts	±5%				Lamp Watts	±10%				LINE CURRENT (Amps)					Operating.....	0.45				Open Circuit.....	1.05				Starting.....	0.70				UL TEMPERATURE RATINGS					Insulation Class	H(180°C)				Coil Temperature Code	1029	A			MIN. AMBIENT STARTING TEMP.	-20°F or -30°C				NOM. OPEN CIRCUIT VOLTAGE	277				INPUT VOLTAGE AT LAMP DROPOUT.....	190				INPUT WATTS	118				RECOMMENDED FUSE (Amps).....	3				CORE and COIL					Dimension (A)	1.80				Dimension (B)	3.10				Weight (lbs.)	3.2				Lead Lengths	12"				CAPACITOR REQUIREMENT					Microfarads	10.0				Volts (min.)	280				Fault Current Withstand (amps)					60 Hz TEST PROCEDURES (Refer to Advance Test Procedure for HID Ballasts - Form 1270)					High Potential Test (Volts)					1 minute	2000				2 seconds	2500				Open Circuit Voltage Test (Volts)	260-290				Short-Circuit Current Test (Amps)					Secondary Current	1.05-1.55				Input Current.....	0.25					0.35				
INPUT VOLTS	277																																																																																																																																																																																					
CIRCUIT TYPE	R-HPF																																																																																																																																																																																					
POWER FACTOR (min)	90%																																																																																																																																																																																					
REGULATION																																																																																																																																																																																						
Line Volts	±5%																																																																																																																																																																																					
Lamp Watts	±10%																																																																																																																																																																																					
LINE CURRENT (Amps)																																																																																																																																																																																						
Operating.....	0.45																																																																																																																																																																																					
Open Circuit.....	1.05																																																																																																																																																																																					
Starting.....	0.70																																																																																																																																																																																					
UL TEMPERATURE RATINGS																																																																																																																																																																																						
Insulation Class	H(180°C)																																																																																																																																																																																					
Coil Temperature Code	1029	A																																																																																																																																																																																				
MIN. AMBIENT STARTING TEMP.	-20°F or -30°C																																																																																																																																																																																					
NOM. OPEN CIRCUIT VOLTAGE	277																																																																																																																																																																																					
INPUT VOLTAGE AT LAMP DROPOUT.....	190																																																																																																																																																																																					
INPUT WATTS	118																																																																																																																																																																																					
RECOMMENDED FUSE (Amps).....	3																																																																																																																																																																																					
CORE and COIL																																																																																																																																																																																						
Dimension (A)	1.80																																																																																																																																																																																					
Dimension (B)	3.10																																																																																																																																																																																					
Weight (lbs.)	3.2																																																																																																																																																																																					
Lead Lengths	12"																																																																																																																																																																																					
CAPACITOR REQUIREMENT																																																																																																																																																																																						
Microfarads	10.0																																																																																																																																																																																					
Volts (min.)	280																																																																																																																																																																																					
Fault Current Withstand (amps)																																																																																																																																																																																						
60 Hz TEST PROCEDURES (Refer to Advance Test Procedure for HID Ballasts - Form 1270)																																																																																																																																																																																						
High Potential Test (Volts)																																																																																																																																																																																						
1 minute	2000																																																																																																																																																																																					
2 seconds	2500																																																																																																																																																																																					
Open Circuit Voltage Test (Volts)	260-290																																																																																																																																																																																					
Short-Circuit Current Test (Amps)																																																																																																																																																																																						
Secondary Current	1.05-1.55																																																																																																																																																																																					
Input Current.....	0.25																																																																																																																																																																																					
	0.35																																																																																																																																																																																					
<p>Capacitor: 7C100M33-R</p>  <p>Capacitance: 10 Dia/Oval Dim: 1.5 Height: 2.9 Temp Rating: 105°C</p>																																																																																																																																																																																						
<p>Ignitor: INTEGRAL</p> <p>An ignitor integral to the core and coil assembly is used to start the lamp.</p> <p>Ballast to Lamp Distance (BTL) = 2 feet Temp Rating: 125°C</p> <p>Data is based upon tests performed by Advance Transformer in a controlled environment and is representative of relative performance. Actual performance can vary depending on operating conditions. Specification</p>	<p>Wiring Diagram:</p>  <p>Fig. H</p> <p>U.L. RECOGNIZED</p>																																																																																																																																																																																					
<b>Typical Ordering Information</b> (please call Advance for suffix availability)																																																																																																																																																																																						
	<table border="1"> <tr> <th>Order Suffix</th> <th>Description</th> </tr> <tr> <td>500DB</td> <td>Ballast With Integral Ignitor and Dry Film Capacitor</td> </tr> <tr> <td>510DB</td> <td>Ballast w/Welded Bracket, Integral Ignitor &amp; Dry Film Cap.</td> </tr> <tr> <td>500B</td> <td>Ballast and Integral Ignitor, No Capacitor</td> </tr> <tr> <td>610B</td> <td>Ballast w/Welded Bracket and Integral Ignitor, No Capacitor</td> </tr> </table>	Order Suffix	Description	500DB	Ballast With Integral Ignitor and Dry Film Capacitor	510DB	Ballast w/Welded Bracket, Integral Ignitor & Dry Film Cap.	500B	Ballast and Integral Ignitor, No Capacitor	610B	Ballast w/Welded Bracket and Integral Ignitor, No Capacitor																																																																																																																																																																											
Order Suffix	Description																																																																																																																																																																																					
500DB	Ballast With Integral Ignitor and Dry Film Capacitor																																																																																																																																																																																					
510DB	Ballast w/Welded Bracket, Integral Ignitor & Dry Film Cap.																																																																																																																																																																																					
500B	Ballast and Integral Ignitor, No Capacitor																																																																																																																																																																																					
610B	Ballast w/Welded Bracket and Integral Ignitor, No Capacitor																																																																																																																																																																																					

**ADVANCE**

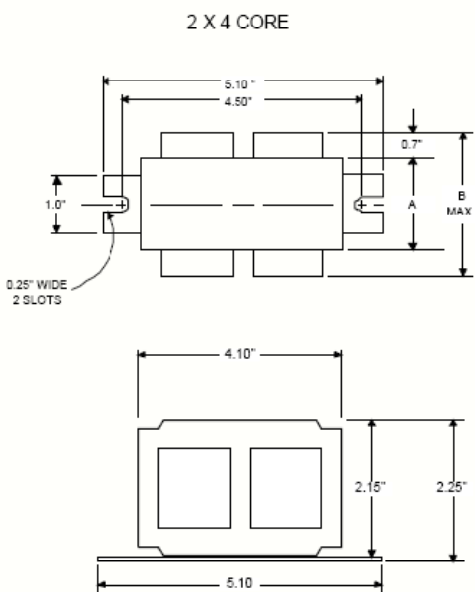
O'HARE INTERNATIONAL CENTER · 10275 WEST HIGGINS ROAD · ROSEMONT, IL 60018  
 Customer Support/Technical Service · Phone: 800-372-3331 · Fax: 630-307-3071  
 Corporate Offices: Phone: 800-322-2086

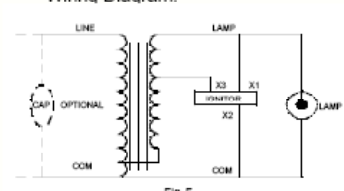
08/12/04

	<b>Metal Halide Lamp Ballast</b>	<b>Catalog Number 71A50M5</b> <b>For 35/39W M130</b> <b>50 Hz HX-HPF</b> <b>Status: Active</b>																																																																																																																																																																																																																								
<b>DIMENSIONS AND DATA</b>																																																																																																																																																																																																																										
<div style="text-align: center;">2 X 4 CORE</div> 	<table border="1" style="width:100%; border-collapse: collapse;"> <tr> <td>INPUT VOLTS</td> <td style="text-align: right;">100</td> <td></td> <td></td> <td></td> <td></td> </tr> <tr> <td>CIRCUIT TYPE</td> <td style="text-align: right;">HX-HPF</td> <td></td> <td></td> <td></td> <td></td> </tr> <tr> <td>POWER FACTOR (min)</td> <td style="text-align: right;">90%</td> <td></td> <td></td> <td></td> <td></td> </tr> <tr> <td>REGULATION</td> <td></td> <td></td> <td></td> <td></td> <td></td> </tr> <tr> <td>  Line Volts</td> <td style="text-align: right;">±5%</td> <td></td> <td></td> <td></td> <td></td> </tr> <tr> <td>  Lamp Watts</td> <td style="text-align: right;">±10%</td> <td></td> <td></td> <td></td> <td></td> </tr> <tr> <td>LINE CURRENT (Amps)</td> <td></td> <td></td> <td></td> <td></td> <td></td> </tr> <tr> <td>  Operating.....</td> <td style="text-align: right;">0.60</td> <td></td> <td></td> <td></td> <td></td> </tr> <tr> <td>  Open Circuit.....</td> <td style="text-align: right;">1.20</td> <td></td> <td></td> <td></td> <td></td> </tr> <tr> <td>  Starting.....</td> <td style="text-align: right;">0.55</td> <td></td> <td></td> <td></td> <td></td> </tr> <tr> <td>UL TEMPERATURE RATINGS</td> <td></td> <td></td> <td></td> <td></td> <td></td> </tr> <tr> <td>  Insulation Class</td> <td style="text-align: right;">H(180°C)</td> <td></td> <td></td> <td></td> <td></td> </tr> <tr> <td>  Coil Temperature Code</td> <td style="text-align: right;">1029</td> <td style="text-align: center;">B</td> <td></td> <td></td> <td></td> </tr> <tr> <td>MIN. AMBIENT STARTING TEMP.</td> <td style="text-align: right;">-20°F or -30°C</td> <td></td> <td></td> <td></td> <td></td> </tr> <tr> <td>NOM. OPEN CIRCUIT VOLTAGE</td> <td style="text-align: right;">245</td> <td></td> <td></td> <td></td> <td></td> </tr> <tr> <td>INPUT VOLTAGE AT LAMP DROPOUT.....</td> <td style="text-align: right;">80</td> <td></td> <td></td> <td></td> <td></td> </tr> <tr> <td>INPUT WATTS</td> <td style="text-align: right;">54</td> <td></td> <td></td> <td></td> <td></td> </tr> <tr> <td>RECOMMENDED FUSE (Amps).....</td> <td style="text-align: right;">2</td> <td></td> <td></td> <td></td> <td></td> </tr> <tr> <td>CORE and COIL</td> <td></td> <td></td> <td></td> <td></td> <td></td> </tr> <tr> <td>  Dimension (A)</td> <td style="text-align: right;">1.90</td> <td></td> <td></td> <td></td> <td></td> </tr> <tr> <td>  Dimension (B)</td> <td style="text-align: right;">2.50</td> <td></td> <td></td> <td></td> <td></td> </tr> <tr> <td>  Weight (lbs.)</td> <td style="text-align: right;">4</td> <td></td> <td></td> <td></td> <td></td> </tr> <tr> <td>  Lead Lengths</td> <td style="text-align: right;">12"</td> <td></td> <td></td> <td></td> <td></td> </tr> <tr> <td>CAPACITOR REQUIREMENT</td> <td></td> <td></td> <td></td> <td></td> <td></td> </tr> <tr> <td>  Microfarads</td> <td style="text-align: right;">45.0</td> <td></td> <td></td> <td></td> <td></td> </tr> <tr> <td>  Volts (min.)</td> <td style="text-align: right;">120</td> <td></td> <td></td> <td></td> <td></td> </tr> <tr> <td>  Fault Current Withstand (amps)</td> <td></td> <td></td> <td></td> <td></td> <td></td> </tr> <tr> <td>80 Hz TEST PROCEDURES (Refer to Advance Test Procedure for HID Ballasts - Form 1270)</td> <td></td> <td></td> <td></td> <td></td> <td></td> </tr> <tr> <td>High Potential Test (Volts)</td> <td></td> <td></td> <td></td> <td></td> <td></td> </tr> <tr> <td>  1 minute</td> <td style="text-align: right;">2000</td> <td></td> <td></td> <td></td> <td></td> </tr> <tr> <td>  2 seconds</td> <td style="text-align: right;">2600</td> <td></td> <td></td> <td></td> <td></td> </tr> <tr> <td>Open Circuit Voltage Test (Volts)</td> <td style="text-align: right;">225-275</td> <td></td> <td></td> <td></td> <td></td> </tr> <tr> <td>Short-Circuit Current Test (Amps)</td> <td></td> <td></td> <td></td> <td></td> <td></td> </tr> <tr> <td>  Secondary Current</td> <td style="text-align: right;">0.45-0.55</td> <td></td> <td></td> <td></td> <td></td> </tr> <tr> <td>  Input Current.....</td> <td style="text-align: right;">0.25</td> <td></td> <td></td> <td></td> <td></td> </tr> <tr> <td></td> <td style="text-align: right;">0.45</td> <td></td> <td></td> <td></td> <td></td> </tr> </table>		INPUT VOLTS	100					CIRCUIT TYPE	HX-HPF					POWER FACTOR (min)	90%					REGULATION						Line Volts	±5%					Lamp Watts	±10%					LINE CURRENT (Amps)						Operating.....	0.60					Open Circuit.....	1.20					Starting.....	0.55					UL TEMPERATURE RATINGS						Insulation Class	H(180°C)					Coil Temperature Code	1029	B				MIN. AMBIENT STARTING TEMP.	-20°F or -30°C					NOM. OPEN CIRCUIT VOLTAGE	245					INPUT VOLTAGE AT LAMP DROPOUT.....	80					INPUT WATTS	54					RECOMMENDED FUSE (Amps).....	2					CORE and COIL						Dimension (A)	1.90					Dimension (B)	2.50					Weight (lbs.)	4					Lead Lengths	12"					CAPACITOR REQUIREMENT						Microfarads	45.0					Volts (min.)	120					Fault Current Withstand (amps)						80 Hz TEST PROCEDURES (Refer to Advance Test Procedure for HID Ballasts - Form 1270)						High Potential Test (Volts)						1 minute	2000					2 seconds	2600					Open Circuit Voltage Test (Volts)	225-275					Short-Circuit Current Test (Amps)						Secondary Current	0.45-0.55					Input Current.....	0.25						0.45				
INPUT VOLTS	100																																																																																																																																																																																																																									
CIRCUIT TYPE	HX-HPF																																																																																																																																																																																																																									
POWER FACTOR (min)	90%																																																																																																																																																																																																																									
REGULATION																																																																																																																																																																																																																										
Line Volts	±5%																																																																																																																																																																																																																									
Lamp Watts	±10%																																																																																																																																																																																																																									
LINE CURRENT (Amps)																																																																																																																																																																																																																										
Operating.....	0.60																																																																																																																																																																																																																									
Open Circuit.....	1.20																																																																																																																																																																																																																									
Starting.....	0.55																																																																																																																																																																																																																									
UL TEMPERATURE RATINGS																																																																																																																																																																																																																										
Insulation Class	H(180°C)																																																																																																																																																																																																																									
Coil Temperature Code	1029	B																																																																																																																																																																																																																								
MIN. AMBIENT STARTING TEMP.	-20°F or -30°C																																																																																																																																																																																																																									
NOM. OPEN CIRCUIT VOLTAGE	245																																																																																																																																																																																																																									
INPUT VOLTAGE AT LAMP DROPOUT.....	80																																																																																																																																																																																																																									
INPUT WATTS	54																																																																																																																																																																																																																									
RECOMMENDED FUSE (Amps).....	2																																																																																																																																																																																																																									
CORE and COIL																																																																																																																																																																																																																										
Dimension (A)	1.90																																																																																																																																																																																																																									
Dimension (B)	2.50																																																																																																																																																																																																																									
Weight (lbs.)	4																																																																																																																																																																																																																									
Lead Lengths	12"																																																																																																																																																																																																																									
CAPACITOR REQUIREMENT																																																																																																																																																																																																																										
Microfarads	45.0																																																																																																																																																																																																																									
Volts (min.)	120																																																																																																																																																																																																																									
Fault Current Withstand (amps)																																																																																																																																																																																																																										
80 Hz TEST PROCEDURES (Refer to Advance Test Procedure for HID Ballasts - Form 1270)																																																																																																																																																																																																																										
High Potential Test (Volts)																																																																																																																																																																																																																										
1 minute	2000																																																																																																																																																																																																																									
2 seconds	2600																																																																																																																																																																																																																									
Open Circuit Voltage Test (Volts)	225-275																																																																																																																																																																																																																									
Short-Circuit Current Test (Amps)																																																																																																																																																																																																																										
Secondary Current	0.45-0.55																																																																																																																																																																																																																									
Input Current.....	0.25																																																																																																																																																																																																																									
	0.45																																																																																																																																																																																																																									
<p>Capacitor: 7C450P12</p>  <p>Capacitance: 45 Dia/Oval Dim: 1.75 Height: 3.75 Temp Rating: 105°C</p>	<p>Wiring Diagram:</p>  <p style="text-align: center;">Fig. F</p>																																																																																																																																																																																																																									
<p>Ignitor: LI533-H4</p> 	<p style="text-align: center;"><b>U.L. RECOGNIZED</b></p> <p style="text-align: center;"><b>Typical Ordering Information</b></p> <p style="text-align: center;">(please call Advance for suffix availability)</p> <table border="1" style="width:100%; border-collapse: collapse;"> <thead> <tr> <th style="width:30%;">Order Suffix</th> <th>Description</th> </tr> </thead> <tbody> <tr> <td>500D.</td> <td>Ballast With Ignitor and Dry Film Capacitor</td> </tr> <tr> <td>510D.</td> <td>Ballast with Welded Bracket, Ignitor &amp; Dry Film Capacitor</td> </tr> <tr> <td>610.</td> <td>Ballast with Welded Bracket and Ignitor, No Capacitor</td> </tr> </tbody> </table>		Order Suffix	Description	500D.	Ballast With Ignitor and Dry Film Capacitor	510D.	Ballast with Welded Bracket, Ignitor & Dry Film Capacitor	610.	Ballast with Welded Bracket and Ignitor, No Capacitor																																																																																																																																																																																																																
Order Suffix	Description																																																																																																																																																																																																																									
500D.	Ballast With Ignitor and Dry Film Capacitor																																																																																																																																																																																																																									
510D.	Ballast with Welded Bracket, Ignitor & Dry Film Capacitor																																																																																																																																																																																																																									
610.	Ballast with Welded Bracket and Ignitor, No Capacitor																																																																																																																																																																																																																									
<p>Data is based upon tests performed by Advance Transformer in a controlled environment and represents only relative performance. Actual performance can vary depending on operating conditions. Specifications are subject to change without notice.</p>																																																																																																																																																																																																																										

**ADVANCE**

O'HARE INTERNATIONAL CENTER · 10275 WEST HIGGINS ROAD · ROSEMONT, IL 60018  
 Customer Support/Technical Service: Phone: 800-372-3331 · Fax: 630-307-3071  
 Corporate Offices: Phone: 800-322-2086

11/13/06

## Appendix B



### Solera® S

Solera S is a 3" thick high thermal performance translucent glazing unit designed to integrate into most and some skylight systems

Solera S is highly configurable. The wide range of configurations allows the building designer to choose performance that is tailored exactly to his / her project. Below are some

	External Veil	Internal Veil	Light Diffusing Power	Visible Light Transmittance (VLT)	Shading coefficient (SC)	Solar Heat Gain Coefficient (SHGC)	U-Value
	401	401	Good	55%	0.61	0.51	.2
	300	401	Excellent	47%	0.52	0.44	.2
	401	300	Excellent	47%	0.52	0.44	.2
	300	300	Excellent	40%	0.44	0.37	.2
Solera S with clear glass	401	545	Excellent	34%	0.38	0.32	.2
	545	401	Excellent	32%	0.36	0.30	.2
	300	545	Excellent	30%	0.33	0.28	.2
	545	300	Excellent	28%	0.31	0.26	.2
	545	545	Excellent	21%	0.23	0.20	.2
Solera S with Solexia glass	401	401	Good	47%	0.40	0.34	.2
	300	401	Excellent	40%	0.34	0.29	.2
	401	300	Excellent	40%	0.34	0.29	.2
	300	300	Excellent	34%	0.29	0.25	.2
	401	545	Excellent	29%	0.25	0.21	.2
	545	401	Excellent	27%	0.23	0.20	.2
	300	545	Excellent	26%	0.22	0.18	.2
	545	300	Excellent	24%	0.21	0.17	.2
	545	545	Excellent	18%	0.15	0.13	.2

## CONSTRUCTION/DIMENSIONS

PRODUCTS



### Construction

Solera glazing units consist of a transparent honeycomb insulation plus light diffusing veils sandwiched between two lites of architectural glass. An energy-efficient metal spacer and structural silicone surround the structure and a breather tube assures air pressure equilibrium.

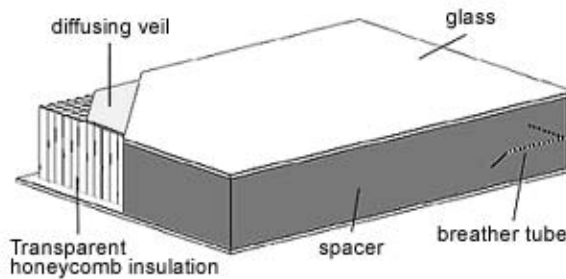

### Dimensions

Unit thickness is 2.5" (64mm) plus glass. Unit widths are available up to 5'(1.5m). Unit heights are available to 12'(3.1m) with greater heights possible on request.

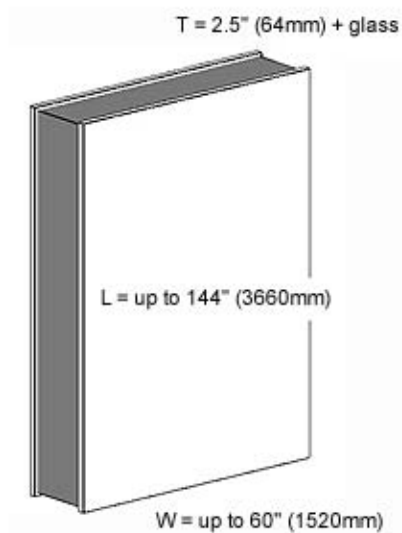



## Appendix C Lighting Controls

GRAFIK Systems

Slider Control

Control Units

omxsl-1 07.09.04

### GRAFIK Slider Control Unit

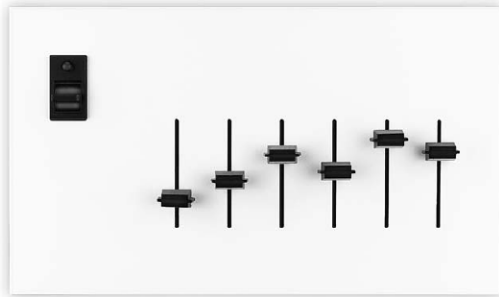

OMXSL-6-4G

#### Description

- Controls up to 12 zones of lighting.
- Allows full-range dimming using zone sliders.
- Controls virtually any light source via dimming panels.
- Mounts in a custom-designed wallbox.

#### Models available to:

- Control 1 to 12 zones of lighting.

#### Slider Control Units work with:

- GP and LP Dimming Panels

Job Name: <input type="text"/>	Model Numbers: OMXSL-7-4G-WH <input type="text"/>	<input type="text"/>
Job Number: <input type="text"/>	<input type="text"/>	<input type="text"/>

GRAFIK Systems	Slider Control	Control Units
----------------	----------------	---------------

omxslid-2 07.09.04

### Specifications

#### Power

- Low-voltage type Class 2 (PELV)  
 Operating voltage: 32VDC.

#### Lighting Sources/Load Types

Controls lighting sources with a smooth, continuous Square Law dimming curve via GP and LP Dimming Panels.

#### Lighting Control

- Sliders provide intuitive method of controlling a local lighting space.

#### Key Design Features

- Meets IEC 801-2. Tested to withstand 15kV electrostatic discharge without damage or memory loss.
- Power failure memory automatically restores lighting to the level selected prior to power interruption.
- Faceplate snaps on with no visible means of attachment.

#### System Communications and Capacities

- Low-voltage type Class 2 (PELV) wiring connects Control Units to other system components.
- The Slider Control Unit counts as one of 32 maximum Wallstations and/or Control Interfaces allowed on a Class 2 (PELV) Wallstation Link.

#### Environment

- 32-104°F (0-40°C). Relative humidity less than 90% non-condensing.

Job Name: <input style="width: 95%;" type="text"/>	Model Numbers: <input style="width: 95%;" type="text" value="OMXSL-7-4G-WH"/>
Job Number: <input style="width: 95%;" type="text"/>	<input style="width: 95%;" type="text"/>

GRAFIK Systems

Slider Control

Control Units

omxslid-3 07.09.04

### How to Build a Model Number

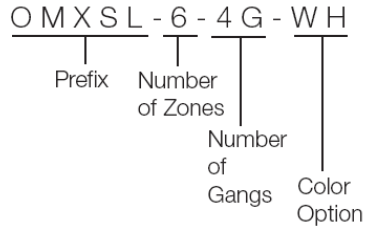

### Model Numbers

Number of Zones	Model Number
1	OMXSL-1-1G-__
2	OMXSL-2-2G-__
3	OMXSL-3-2G-__
4	OMXSL-4-3G-__
5	OMXSL-5-3G-__
6	OMXSL-6-4G-__
7	OMXSL-7-4G-__
8	OMXSL-8-5G-__
9	OMXSL-9-5G-__
10	OMXSL-10-6G-__
11	OMXSL-11-6G-__
12	OMXSL-12-7G-__

**Prefix:**

OMXSL for GRAFIK Slider Control Units

**Number of Zones:**

1,2,3,4,5,6,7,8,9,10,11, or 12

**Number of Gangs:**

Indicates number of wallbox gangs required for installation. Example: 4G = 4 gangs.

**Color Option:**

**Architectural Matte Finishes**

- White WH
- Ivory IV
- Beige BE
- Gray GR
- Brown BR
- Black BL

**Architectural Metal Finishes**

- Bright Brass BB
- Bright Chrome BC
- Satin Brass SB

Job Name: <input style="width: 90%;" type="text"/>	Model Numbers: <input style="width: 90%;" type="text" value="OMXSL-7-4G-WH"/>
Job Number: <input style="width: 90%;" type="text"/>	<input style="width: 90%;" type="text"/>

**GRAFIK Systems**

**Slider Control**

**Control Units**

omxslid 4 07.09.04

**Dimensions**

Model Number	Wallbox Size	Width	Height	Depth <sup>1</sup>
OMXSL-1-1G-__	Single-gang	2.31" (59mm)	4.06" (103mm)	3.00" (76mm)
OMXSL-2-2G-__	Two-gang	4.13" (105mm)	4.06" (103mm)	3.00" (76mm)
OMXSL-3-2G-__	Two-gang	4.13" (105mm)	4.06" (103mm)	3.00" (76mm)
OMXSL-4-3G-__	Three-gang	5.94" (151mm)	4.06" (103mm)	3.00" (76mm)
OMXSL-5-3G-__	Three-gang	5.94" (151mm)	4.06" (103mm)	3.00" (76mm)
OMXSL-6-4G-__	Four-gang	7.88" (200mm)	4.06" (103mm)	3.00" (76mm)
OMXSL-7-4G-__	Four-gang	7.88" (200mm)	4.06" (103mm)	3.00" (76mm)
OMXSL-8-5G-__	Five-gang	9.56" (243mm)	4.06" (103mm)	3.00" (76mm)
OMXSL-9-5G-__	Five-gang	9.56" (243mm)	4.06" (103mm)	3.00" (76mm)
OMXSL-10-6G-__	Six-gang	11.38" (289mm)	4.06" (103mm)	3.00" (76mm)
OMXSL-11-6G-__	Six-gang	11.38" (289mm)	4.06" (103mm)	3.00" (76mm)
OMXSL-12-7G-__	Seven-gang	13.19" (335mm)	4.06" (103mm)	3.00" (76mm)

<sup>1</sup> Depth includes wallplate and backbox. Wallplate depth is 0.25" (6.35mm)

Job Name: <input type="text"/>	Model Numbers: OMXSL-7-4G-WH <input type="text"/>	<input type="text"/>
Job Number: <input type="text"/>	<input type="text"/>	<input type="text"/>

GRAFIK Systems

OMX-4600

Preset Dimming Controls

4600-1 04.05.04

### OMX-4600 Control Unit

Cover (shown open)



#### Description

- Used with GRAFIK 5000/6000/7000 lighting control systems.
- Supplies dimming for up to 24 zones of lighting<sup>1</sup>.
- Provides pushbutton recall of four preset lighting scenes, plus Off.
- Controls virtually any light source via dimming and switching panels.
- Provides lockout options to prevent accidental changes.
- Includes built-in infrared receiver for operation with an optional remote control.

#### Models available to:

- Control two to 24 zones of lighting<sup>1</sup>.

<sup>1</sup> OMX-4600 Control Unit zones count towards the maximum number of zones allowed in GRAFIK 5000/6000/7000 Systems.

Job Name:	Model Numbers:	
<input type="text"/>	OMX-4624-A-VH	<input type="text"/>
Job Number:	<input type="text"/>	<input type="text"/>

GRAFIK Systems

OMX-4600

Preset Dimming Controls

4600-2 04.05.04

## Specifications

### Power

- Low-voltage type Class 2 (PELV)  
 Operating voltage: 32 V Direct Current.

### Lighting Sources/Load Types

Controls lighting sources with a smooth, continuous Square Law dimming curve or on a full conduction non-dim basis via GP and LP Dimming Panels and XP Softswitch™ Panels.

### Preset Control

- 4 preset lighting scenes and off are accessible from the Control Unit front panel.
- Additional scenes are stored in Processor Panel. These scenes are accessible via Wallstations, Control Interfaces, and/or PC.
- Light levels fade smoothly between scenes. Fade time can be set differently for each scene, between 0-59 sec. or 1-60 min. Fade time from Off is capped at 5 sec. Fade time can be set differently for each zone through the Processor.

### Key Design Features

- Meets IEC 801-2. Tested to withstand 15kV electrostatic discharge without damage or memory loss.
- Power failure memory automatically restores lighting to the scene selected prior to power interruption.
- Faceplate snaps on with no visible means of attachment.

### System Communications and Capacities

- Low-voltage type Class 2 (PELV) wiring connects Control Units to other system components.
- The OMX-4600 Control Unit counts as one of 32 maximum Wallstations and/or Control Interfaces allowed on a Class 2 (PELV) Wallstation Link.

### Environment

- 32-104°F (0-40°C). Relative humidity less than 90% non-condensing.

Job Name: <input style="width: 90%;" type="text"/>	Model Numbers: <input style="width: 95%;" type="text" value="OMX-4624-A-WH"/>
Job Number: <input style="width: 80%;" type="text"/>	<input style="width: 95%;" type="text"/>



GRAFIK Systems

OMX-4600

Preset Dimming Controls

4600-3 04.05.04

### How to Build a Model Number

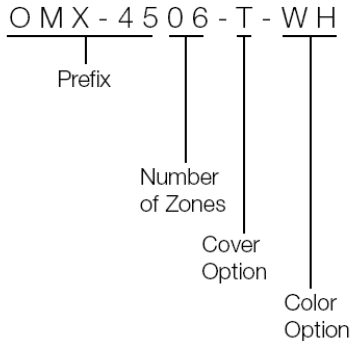

**Prefix:**

**OMX** for Control Units used with GRAFIK 5000/6000/7000 systems.

**Number of Zones:**

2, 3, 4, 6, 8, 16, or 24

**Cover Option:**

A for Opaque  
T for Translucent Black

**Color Option:**

See Color Options list

**Model Numbers**

Number of Zones	Standard Setup
2	OMX-4602-__
3	OMX-4603-__
4	OMX-4604-__
6	OMX-4606-__
8	OMX-4608-__
16	OMX-4616-__
24	OMX-4624-__

**Cover Options**

Opaque A  
Cover and Base will match.

Translucent Black T  
Black Cover and choice of Base color.

Also available:  
- Custom controls  
- Color matching  
- Engraving

These options ship in 4 to 6 weeks.

**Color Options**

**Architectural Matte Finishes**

Standard – Ship in 48 hours

Cover Option: A or T

White WH

Ivory IV

Beige BE

Gray GR

Brown BR

Black BL

**Designer Gloss Finishes**

Ship in 4 to 6 weeks

Cover Option: A only

White GWH

Ivory GIV

Light Almond GLA

Almond GAL

**Satin Color Matte Finishes**

Cover Option: A or T

Hot HT

Ochre OC

Terracotta TC

Desert Stone DS

Stone ST

Limestone LS

Blue Mist BT

Midnight MN

Taupe TP

Biscuit BI

Eggshell ES

Snow SW

**Architectural Metal Finishes**

Cover Option: T only

Bright Brass BB

Bright Chrome BC

Bright Nickel BN

Satin Brass SB

Satin Chrome SC

Satin Nickel SN

Antique Brass QB

Antique Bronze QZ

**Anodized Aluminum Finishes**

Cover Option: T only

Clear CLA

Black BLA

Brass BRA

Bronze BZA

Job Name:	Model Numbers:	
<input type="text"/>	<input type="text" value="OMX-4624-A-WH"/>	<input type="text"/>
Job Number:	<input type="text"/>	<input type="text"/>







GRAFIK Systems

OMX-4600

Preset Dimming Controls

4600-4 04.05.04

Dimensions and Mounting

Model	Side View	A	B	C	Wallbox <sup>1</sup> U.S. Size	Depth
2-Zone: OMX-4602		4 5/16" (123mm)	1 13/16" (46mm)	5.56" (141mm)	2 Gang	3.5" (89mm)
3-Zone: OMX-4603		6 11/16" (168mm)	3 5/8" (92mm)	7.25" (184mm)	3 Gang	3.5" (89mm)
4-Zone: OMX-4604		8 5/16" (208mm)	5 7/16" (138mm)	8.94" (227mm)	4 Gang	3.5" (89mm)
6-Zone: OMX-4606		8 5/16" (208mm)	5 7/16" (138mm)	8.94" (227mm)	4 Gang	3.5" (89mm)
8-Zone: OMX-4608		8 5/16" (208mm)	5 7/16" (138mm)	8.94" (227mm)	4 Gang	3.5" (89mm)
16-Zone: OMX-4616		8 5/16" (208mm)	5 7/16" (138mm)	8.94" (227mm)	4 Gang	3.5" (89mm)
24-Zone: OMX-4624		8 5/16" (208mm)	5 7/16" (138mm)	8.94" (227mm)	4 Gang	3.5" (89mm)

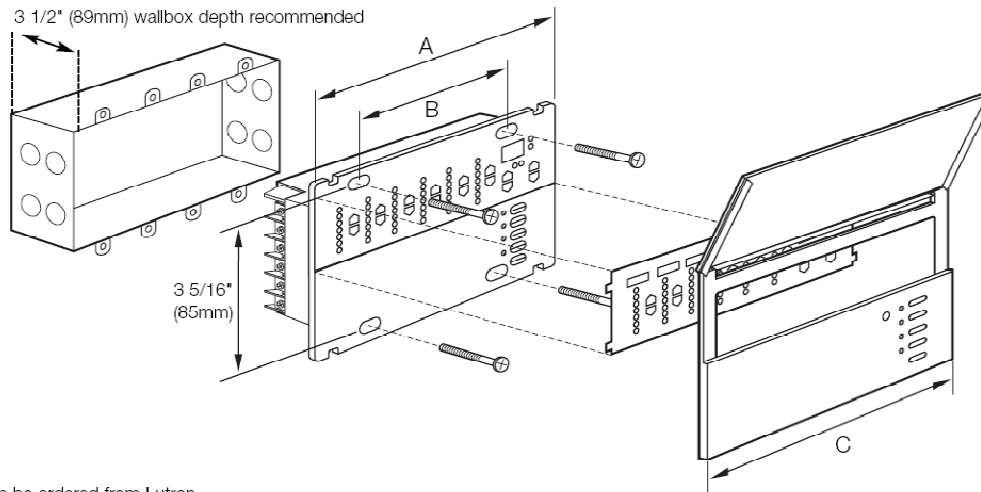
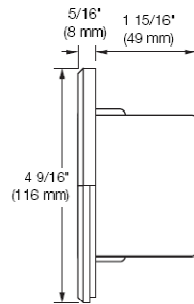

<sup>1</sup> Can be ordered from Lutron.

Job Name:	Model Numbers:	
<input type="text"/>	OMX-4624-A-WH	<input type="text"/>
Job Number:	<input type="text"/>	<input type="text"/>

## Appendix D

Virginia Electric and Power Company

N:\Rates\Retail Rate Schedules\Virginia Jurisdiction\Currently Approved\Rate Schedules\Bundled\SchGS3

Schedule GS-3  
LARGE GENERAL SERVICE  
SECONDARY VOLTAGE

---

### I. APPLICABILITY

- A. Except as modified herein, this schedule is applicable only to a non-residential secondary voltage Customer (as defined in Paragraph XI.) who elects to receive Electricity Supply Service and Electric Delivery Service from the Company and whose peak measured demand has reached or exceeded 500 kW during at least three billing months within the current and previous 11 billing months.
- B. For a Customer served under this schedule whose peak measured demand has decreased to less than 500 kW, this schedule shall remain applicable to the Customer and the Customer shall not have the option to purchase electricity under Schedule GS-1, GS-2 or GS-2T until such time the maximum measured demand has remained at less than 500 kW during all billing months within the current and previous 11 billing months.
- C. Notwithstanding any other provisions of this schedule, if a Customer: (1) received or was eligible to receive service under this schedule during the preceding 24 months; (2) installed and began operating bona fide automated load management equipment or high-efficiency equipment which replaces standard-efficiency equipment; and (3) is currently ineligible for service under Paragraphs I.A. and I.B. because of the installation and operation of such equipment, then the customer shall be eligible for service under this schedule. Once service is provided under this Paragraph I.C., service may continue to be supplied under this schedule only so long as the Customer regularly operates such equipment in a bona fide manner. The type and design of such equipment must be approved by the Company and the equipment shall be subject to inspection by the Company.
- D. At such time the Customer no longer meets the above applicability requirements, the Customer will remain on this schedule for the period (not exceeding two additional billing months) required to achieve an orderly transfer to the applicable schedule.
- E. For new service, this schedule is applicable when the anticipated kW demand meets the criteria of Paragraph I.A., above.

(Continued)

Filed 06-28-07  
Electric-Virginia

Superseding Filing Effective For Usage On and  
After 01-01-04. This Filing Effective For  
Usage On and After 07-01-07.

Virginia Electric and Power Company

N:\Rates\Retail Rate Schedules\Virginia Jurisdictional\Currently Approved\Rate Schedules\Bundled\SchGS3

Schedule GS-3  
LARGE GENERAL SERVICE  
SECONDARY VOLTAGE

---

II. 30-DAY RATE

A. Distribution Service Charges

1. Basic Customer Charge  
Basic Customer Charge \$119.80 per billing month.
2. Plus Distribution Demand Charge  
All kW of Distribution Demand @ \$2.120 per kW
3. Plus rkVA Demand Charge @ \$0.15 per rkVA

B. Electricity Supply Service Charges

1. On-Peak Electricity Supply Demand Charge  
All On-Peak kW @ \$12.154 per kW
2. Plus Off-Peak Electricity Supply Demand Charge  
All Off-Peak kW @ \$0.656 per kW
3. Plus Electricity Supply Adjustment Demand Charge  
All kW of Demand @ (\$0.640) per kW
4. Plus Electricity Supply kWh Charge  
All On-peak kWh @ 0.404¢ per kWh  
All Off-peak kWh @ 0.272¢ per kWh
5. Each Electricity Supply kilowatthours used are subject to Fuel Charge Rider A.

C. The minimum charge shall be as may be contracted for.

(Continued)

Filed 06-28-07  
Electric-Virginia

Superseding Filing Effective For Usage On and  
After 01-01-04. This Filing Effective For  
Usage On and After 07-01-07.

Virginia Electric and Power Company  
N:\Rates\Retail Rate Schedules\Virginia Jurisdiction\Currently Approved\Rate Schedules\Bundled\SchGS3

Schedule GS-3  
LARGE GENERAL SERVICE  
SECONDARY VOLTAGE

(Continued)

III. DETERMINATION OF ON-PEAK AND OFF-PEAK HOURS

The following on-peak and off-peak hours are applicable to the billing of all charges stated in this schedule.

A. On-peak hours are as follows:

1. For the period of June 1 through September 30, 10 a.m. to 10 p.m., Mondays through Fridays.
2. For the period of October 1 through May 31, 7 a.m. to 10 p.m., Mondays through Fridays.

B. All hours not specified in III.A. are off-peak.

IV. DETERMINATION OF DISTRIBUTION DEMAND

A. The Distribution Demand billed under Paragraph II.A.2. shall be such as may be contracted for but not less than the highest of:

1. The highest average kW measured at the location during any 30-minute interval of the current and previous 11 billing months.
2. 500 kW.

B. When the Customer's power factor is less than 85 percent, a minimum Distribution Demand of not less than 85 percent of the Customer's maximum kVA demand may be established.

V. DETERMINATION OF rkVA DEMAND

The rkVA of demand billed shall be the highest average rkVA measured in any 30-minute interval during the current billing month.

(Continued)

Filed 06-28-07  
Electric-Virginia

Superseding Filing Effective For Usage On and  
After 01-01-04. This Filing Effective For  
Usage On and After 07-01-07.

Virginia Electric and Power Company

N:\Rates\Retail Rate Schedules\Virginia Jurisdiction\Currently Approved\Rate Schedules\Bundled\SchGS3

Schedule GS-3  
LARGE GENERAL SERVICE  
SECONDARY VOLTAGE

(Continued)

VI. DETERMINATION OF ON-PEAK ELECTRICITY SUPPLY DEMAND

The kW of demand billed under II.B.1. shall be the highest of:

- A. The highest average kW measured in any 30-minute interval of the current billing month during on-peak hours.
- B. Seventy-five percent of the highest kW of demand at this location as determined under VI.A., above, during the billing months of June through September of the preceding 11 billing months.
- C. 100 kW.

VII. DETERMINATION OF OFF-PEAK ELECTRICITY SUPPLY DEMAND

The kW of demand billed under Paragraph II.B.2. shall be the off-peak demand which is in excess of 90% of the On-Peak Electricity Supply Demand determined under Paragraph VI.

VIII. DETERMINATION OF ELECTRICITY SUPPLY ADJUSTMENT DEMAND

This credit is required in order to achieve customer bill neutrality, arising from changes to the Distribution Demand Charge while maintaining the overall capped rates. The kW of demand billed under Paragraph II.B.3. shall be the Distribution Demand determined under Paragraph IV.

IX. METER READING AND BILLING

When the actual number of days between meter readings is more or less than 30 days, the Basic Customer Charge, the Distribution Demand Charge, the rkVA Demand Charge, the On-Peak Electricity Supply Demand Charge, the Off-Peak Electricity Supply Demand Charge, the Electricity Supply Adjustment Demand Charge, and the minimum charge of the 30-day rate will each be multiplied by the actual number of days in the billing period and divided by 30.

(Continued)

Filed 06-28-07  
Electric-Virginia

Superseding Filing Effective For Usage On and  
After 01-01-04. This Filing Effective For  
Usage On and After 07-01-07.



Virginia Electric and Power Company

N:\Rates\Retail Rate Schedules\Virginia Jurisdictional\Currently Approved\Rate Schedules\Bundled\SchGS3

Schedule GS-3  
LARGE GENERAL SERVICE  
SECONDARY VOLTAGE

(Continued)

X. STANDBY, MAINTENANCE OR PARALLEL OPERATION SERVICE

A Customer requiring standby, maintenance or parallel operation service may elect service under this schedule provided the Customer contracts for the maximum kW which the Company is to supply. Standby, maintenance or parallel operation service is subject to the following provisions:

- A. Suitable relays and protective apparatus shall be furnished, installed, and maintained at the Customer's expense in accordance with specifications furnished by the Company. The relays and protective equipment shall be subject, at all reasonable times, to inspection by the Company's authorized representative.
- B. In case the Distribution Demand determined under Paragraph IV. exceeds the contract demand, the contract demand shall be increased by such excess demand.
- C. The demand billed under II.A.2. and II.B.3. shall be the contract demand.

XI. DEFINITION OF TRANSMISSION, PRIMARY AND SECONDARY VOLTAGE CUSTOMER

- A. A transmission voltage Customer is any Customer whose delivery voltage is 69 kV or above.
- B. A primary voltage Customer is any Customer (a) served from a circuit of 69 kV or more where the delivery voltage is 4,000 volts or more, (b) served from a circuit of less than 69 kV where Company-owned transformation is not required at the Customer's site, (c) where Company-owned transformation has become necessary at the Customer's site because the Company has changed the voltage of the circuit from that originally supplied, or (d) at a location served prior to October 27, 1992 where the Customer's connection to the Company's facilities is made at 2,000 volts or more.
- C. A secondary voltage Customer is any Customer not defined in XI.A. or XI.B. as a transmission or primary voltage Customer.

(Continued)

Filed 06-28-07  
Electric-Virginia

Superseding Filing Effective For Usage On and  
After 01-01-04. This Filing Effective For  
Usage On and After 07-01-07.

Virginia Electric and Power Company

N:\Rates\Retail Rate Schedules\Virginia Jurisdictional\Currently Approved\Rate Schedules\Bundled\SchGS3

Schedule GS-3  
LARGE GENERAL SERVICE  
SECONDARY VOLTAGE

---

(Continued)

XII. TERM OF CONTRACT

The contract shall be open order unless (a) standby, maintenance or parallel operation service is provided, or (b) the Customer or the Company requests a written contract. In such cases, the term of contract for the purchase of electricity under this schedule shall be as mutually agreed upon, but for not less than one year. During the minimum term of applicability, the Customer may be billed under the corresponding Unbundled Rate Schedule, Schedule GS-3U, if applicable.

Filed 06-28-07  
Electric-Virginia

Superseding Filing Effective For Usage On and  
After 01-01-04. This Filing Effective For  
Usage On and After 07-01-07.

## Appendix E



### BP 5170

170-Watt High-Efficiency  
Monocrystalline Photovoltaic Modules

The BP 5170 photovoltaic module uses the world's leading commercial laser cell processing technology to produce volume-manufactured photovoltaics with exceptional efficiency. Its premium laser-grooved buried grid monocrystalline cells and large module area provide a premium power performance of 170 watts nominal maximum power and 24 volts of nominal output, providing more power than any other BP Solar module. Powering DC loads or, with an inverter, AC loads, its high efficiency is particularly suited for applications that need maximum energy generation from a limited array area, and for climates with poor insolation. Applications include utility grid-connected residential and commercial roof systems, building facades, distributed generation systems, telecommunication systems, and other arrays requiring high energy density.

Available versions include:

- BP 5170S – Framed module with rugged clear-anodized frame;
- BP 5170L – Unframed laminate version of the BP 5170S.

#### Proven Materials and Construction

BP Solar's quarter-century of field experience shows in every aspect of these modules' construction and materials:

- Frame strength exceeds requirements of certifying agencies;
- Laser patterning and processing minimizes cell front shading, maximizes efficiency;
- 72 high-efficiency monocrystalline cells laminated between sheets of ethylene vinyl acetate (EVA) and high-transmissivity low-iron 3mm tempered glass;
- Integral bypass diodes;
- Asymmetrical cables enable side-by-side or end-to-end module placement in arrays
- DC-rated plug-and-socket connectors provide reliable low-resistance connections and eliminate wiring errors.



#### DC Connectors

#### Limited Warranties

- Power output for 25 years;
- Freedom from defects in materials and workmanship for 5 years.

See our website or your local representative for full terms of these warranties.

©2002 BP Solar Global Marketing



#### Clear Anodized Universal Frame

#### Quality and Safety

- Manufactured in ISO 9001-certified factories;
- Conforms to Directives 89/336/EEC, 73/23/EEC and 93/08/EEC of the European Community;
- BP 5170S is listed by Underwriter's Laboratories for electrical and fire safety (Class C fire rating);
- BP 5170S is certified by TUV Rheinland as Class II equipment;
- BP 5170S complies with the requirements of IEC 61215, including:
  - repetitive cycling between -40°C and 85°C at 85% relative humidity;
  - simulated impact of 23mm (one-inch) ball at terminal velocity;
  - a "hot-spot" test, which determines a module's ability to tolerate localized shadowing (which can cause reverse-biased operation and localized heating);
  - static loading, front and back, of 2400 pascals (50 psf); front loading (e.g. snow) of 5400 pascals (113 psf).
- The BP 5170L is recognized by Underwriter's Laboratories for electrical and fire safety.



BP 5170S



01-3004-3B 6/02

**Electrical Characteristics<sup>1</sup>**

	BP 5170	BP 5160 <sup>4</sup>
Maximum power ( $P_{max}$ ) <sup>3</sup>	170W	160W
Voltage at $P_{max}$ ( $V_{mp}$ )	36.0V	36.0V
Current at $P_{max}$ ( $I_{mp}$ )	4.72A	4.44A
Warranted minimum $P_{max}$	161.5W	152W
Short-circuit current ( $I_{sc}$ )	5.0A	4.7A
Open-circuit voltage ( $V_{oc}$ )	44.2V	44.0V
Temperature coefficient of $I_{sc}$	(0.065±0.015)%/°C	
Temperature coefficient of $V_{oc}$	-(160±10)mV/°C	
Temperature coefficient of power	-(0.5±0.05)%/°C	
NOCT <sup>2</sup>	47±2°C	
Maximum series fuse rating	15A	
Maximum system voltage	600V (U.S. NEC rating) 1000V (TÜV Rheinland rating)	

**Notes**

- These data represent the performance of typical BP 5160 and BP 5170 modules and laminates as measured at their output terminals. The data are based on measurements made in accordance with ASTM E1036 corrected to SRC (Standard Reporting Conditions, also known as STC or Standard Test Conditions), which are:
  - illumination of 1 kW/m<sup>2</sup> (1 sun) at spectral distribution of AM 1.5 (ASTM E892 global spectral irradiance);
  - cell temperature of 25°C.
- The cells in an illuminated module operate hotter than the ambient temperature. NOCT (Nominal Operating Cell Temperature) is an indicator of this temperature differential, and is the cell temperature under Standard Operating Conditions: ambient temperature of 20°C, solar irradiation of 0.8 kW/m<sup>2</sup>, and wind speed of 1m/s.
- During the stabilization process which occurs during the first few months of deployment, module power may decrease approximately 3% from typical  $P_{max}$ .
- The power of solar cells varies in the normal course of production; the BP 5160 is assembled using cells of slightly lower power than the BP 5170.

**BP 5170 I-V Curves**

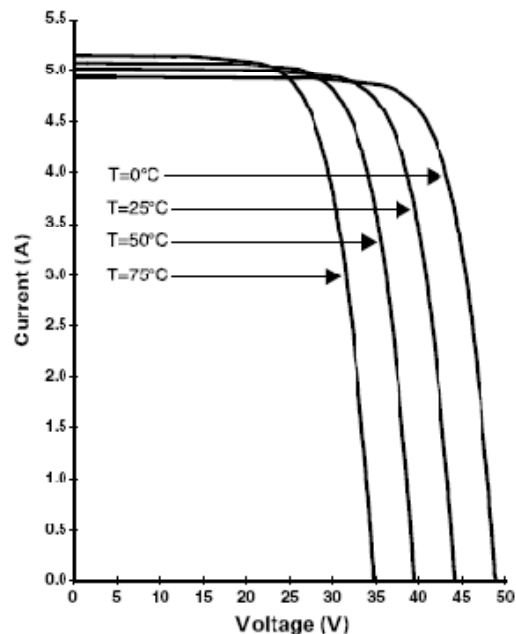

### Mechanical Characteristics

**Weight**

BP 5170S 15.0 kg (33.1 pounds)  
 BP 5170L 12.4 kg (27.3 pounds)

**Dimensions**

BP 5170S: See drawing  
 BP 5170L: 1580 [62.2] x 783 [30.8] x 19 [0.75]  
 Unbracketed dimensions are in millimeters.  
 Bracketed dimensions are in inches.  
 Overall tolerances  $\pm 3\text{mm}$  (1/8")

**Output**

Asymmetrical RHW AWG# 12 (3.3mm<sup>2</sup>)  
 2-conductor cable with weatherproof polarized connectors

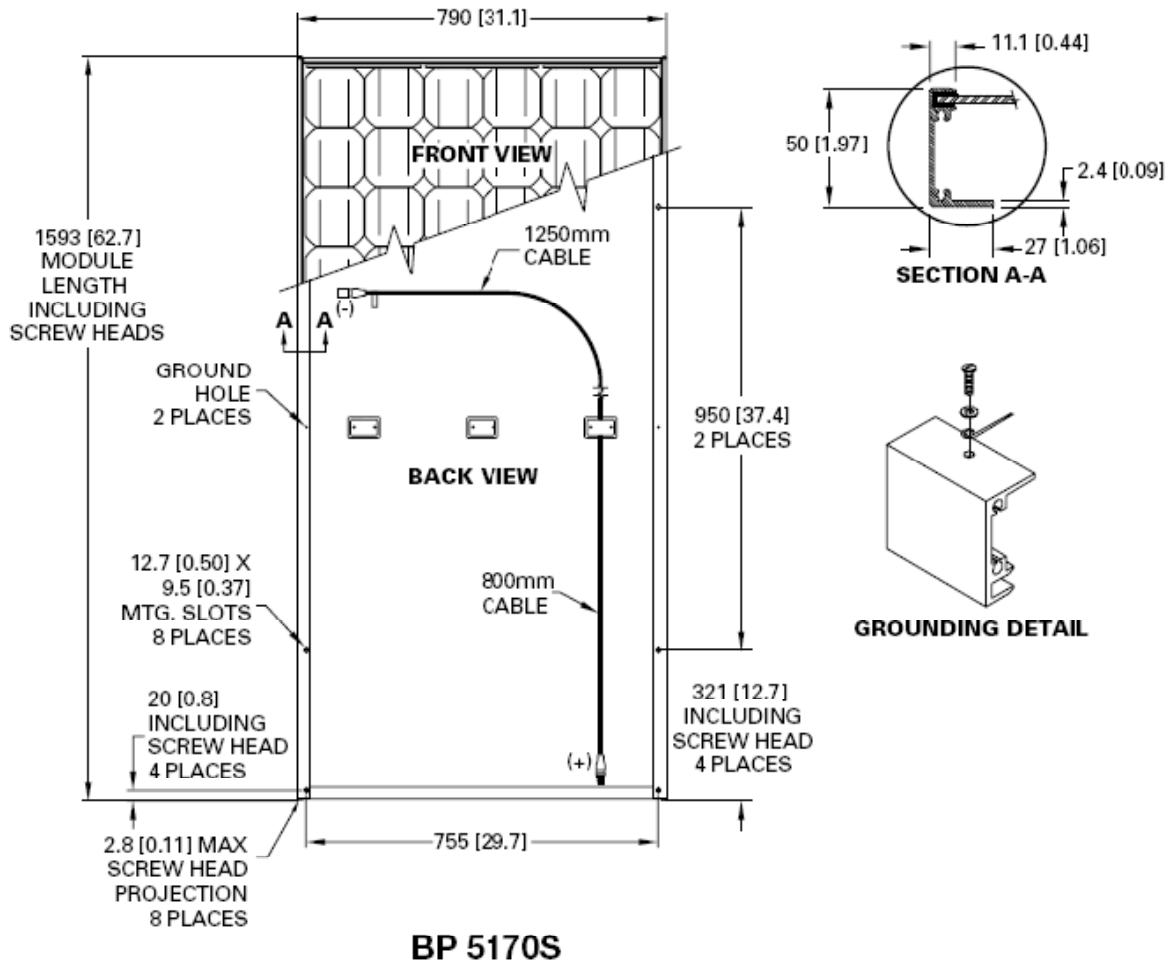

# Appendix F



## 3 N, NI, NA, NIA

Maximum Sheet Length 42'-0"  
Extra Charge for Lengths Under 6'-0"  
ICBO Approved (No.3415)

ROOF

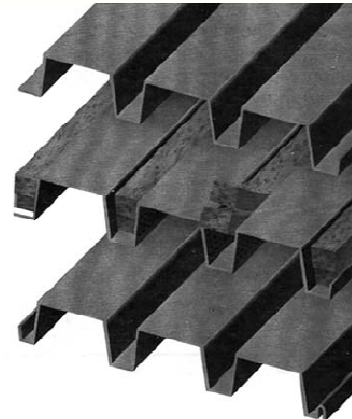
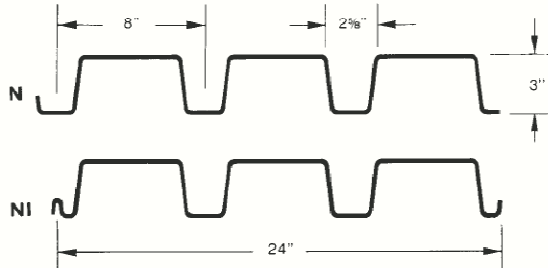

### SECTION PROPERTIES

Deck Type	Design Thick.	Weight (PSF)		I in <sup>4</sup> /ft	Sp in <sup>3</sup> /ft	S <sub>n</sub> in <sup>3</sup> /ft	F <sub>y</sub> KSI
		Ptd.	Galv.				
N22	0.0295	2.16	2.26	0.772	0.382	0.433	33
N21	0.0329	2.40	2.50	0.876	0.445	0.497	33
N20	0.0358	2.61	2.71	0.964	0.501	0.552	33
N19	0.0418	3.05	3.15	1.153	0.597	0.659	33
N18	0.0474	3.46	3.66	1.334	0.688	0.749	33
N16	0.0598	4.36	4.46	1.745	0.893	0.944	33

Acoustical deck (Type 3 NA, NIA) is particularly suitable in structures such as auditoriums, schools and theaters where sound control is desirable. Acoustic perforations are located in the vertical webs where the load carrying properties are negligibly affected (less than 5%).

Inert, non-organic glass fiber sound absorbing batts are placed in the rib openings to absorb up to 70% of the sound striking the deck.

Batts are field installed and may require separation.

### ACOUSTICAL INFORMATION

Deck Type	Absorption Coefficient						Noise Reduction Coefficient*
	125	250	500	1000	2000	4000	
3NA, 3NIA	.14	.36	.89	.95	.53	.34	.70

\* Source: Riverbank Acoustical Laboratories — RAL™ A95-21.  
Test was conducted with 3 inches of 1.65 pcf fiberglass insulation on 3 inch FPS Plaza deck for the SDI

### VERTICAL LOADS FOR TYPE 3N

No. of Spans	Deck Type	Max. SDI Const. Span	Allowable Total (Dead + Live) Uniform Load (PSF)											
			Span (ft.-in.) C. to C. of Support											
			10'-0	10'-6	11'-0	11'-6	12'-0	12'-6	13'-0	13'-6	14'-0	14'-6	15'-0	
1	N22	11'-7	51	46	42	38	35	32	30	28	26	24	23	
	N21	12'-5	59	53	47	43	39	36	33	30	28	26	25	
	N20	13'-2	66	58	52	47	42	38	35	33	30	28	26	
	N19	14'-7	79	69	61	55	50	45	41	38	35	32	30	
	N18	15'-11	91	80	71	63	57	52	47	43	40	37	34	
	N16	18'-6	119	105	93	83	74	66	60	55	50	46	43	
2	N22	14'-0	58	52	48	44	40	37	34	32	29	27	26	
	N21	15'-9	66	60	55	50	46	42	39	36	34	32	29	
	N20	16'-6	74	67	61	56	51	47	44	40	38	35	33	
	N19	18'-1	88	80	73	66	61	56	52	48	45	42	39	
	N18	19'-5	100	91	83	76	69	64	59	55	51	47	44	
	N16	22'-3	126	114	104	95	87	81	74	69	64	60	56	
3	N22	14'-9	70	65	60	55	50	46	43	40	37	34	32	
	N21	15'-9	83	75	68	63	58	53	49	45	42	39	37	
	N20	16'-6	92	83	76	70	64	59	54	50	47	44	41	
	N19	18'-1	110	100	91	83	76	70	65	60	56	52	49	
	N18	19'-5	125	113	103	94	87	80	74	68	64	60	56	
	N16	22'-3	157	143	130	119	109	101	93	86	80	74	69	

Notes: 1. Load tables are calculated using sectional properties based on the steel design thickness shown in the Steel Deck Institute (SDI) Design Manual.  
2. Loads shown in the shaded areas are governed by the live load deflection not in excess of 1/240 of the span. A dead load of 10 PSF has been included.  
3. 3N, NI, NA, NIA are not covered under Factory Mutual.



### Appendix G Main Entrance Courtyard Plan

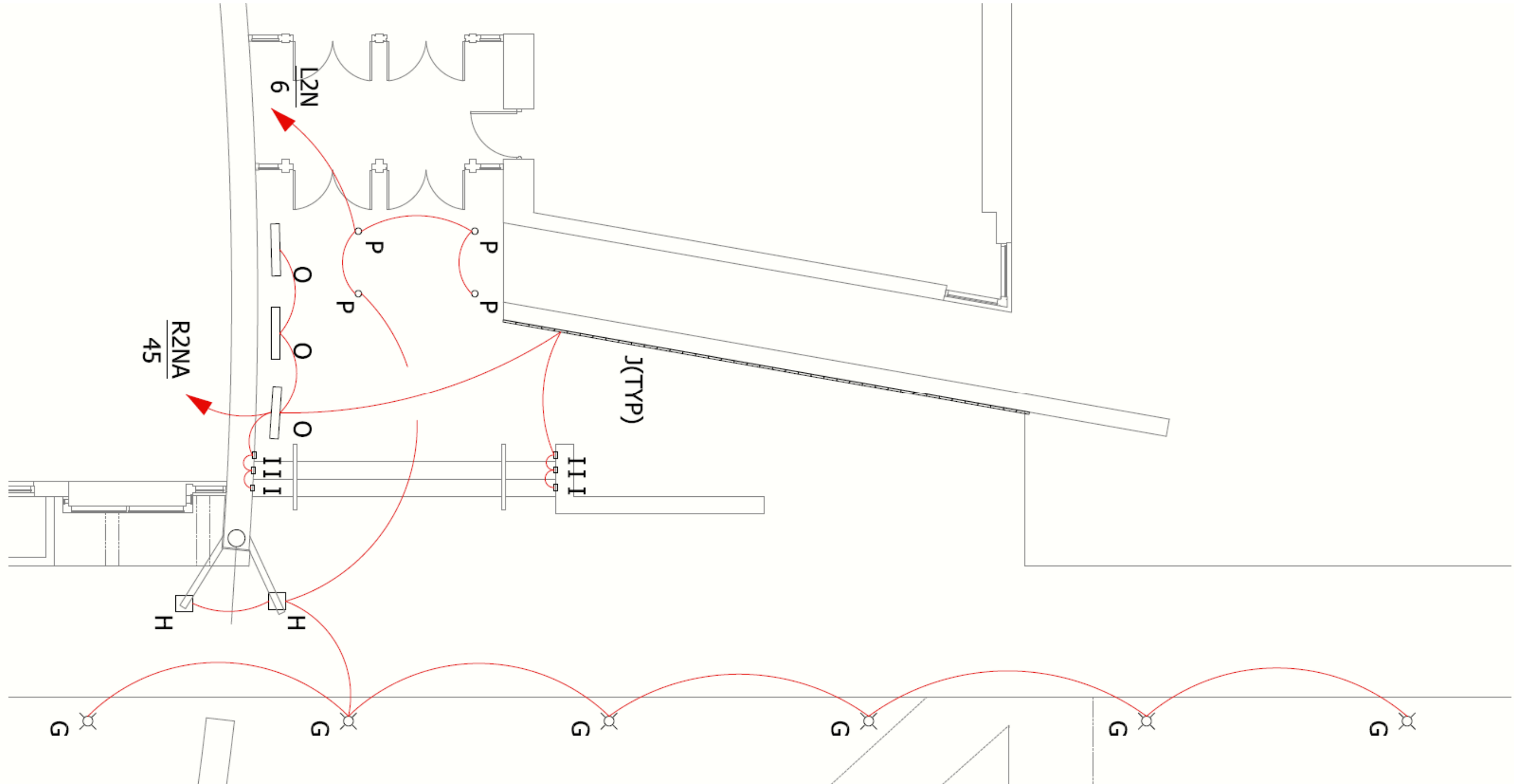

## Appendix H Lobby Plan

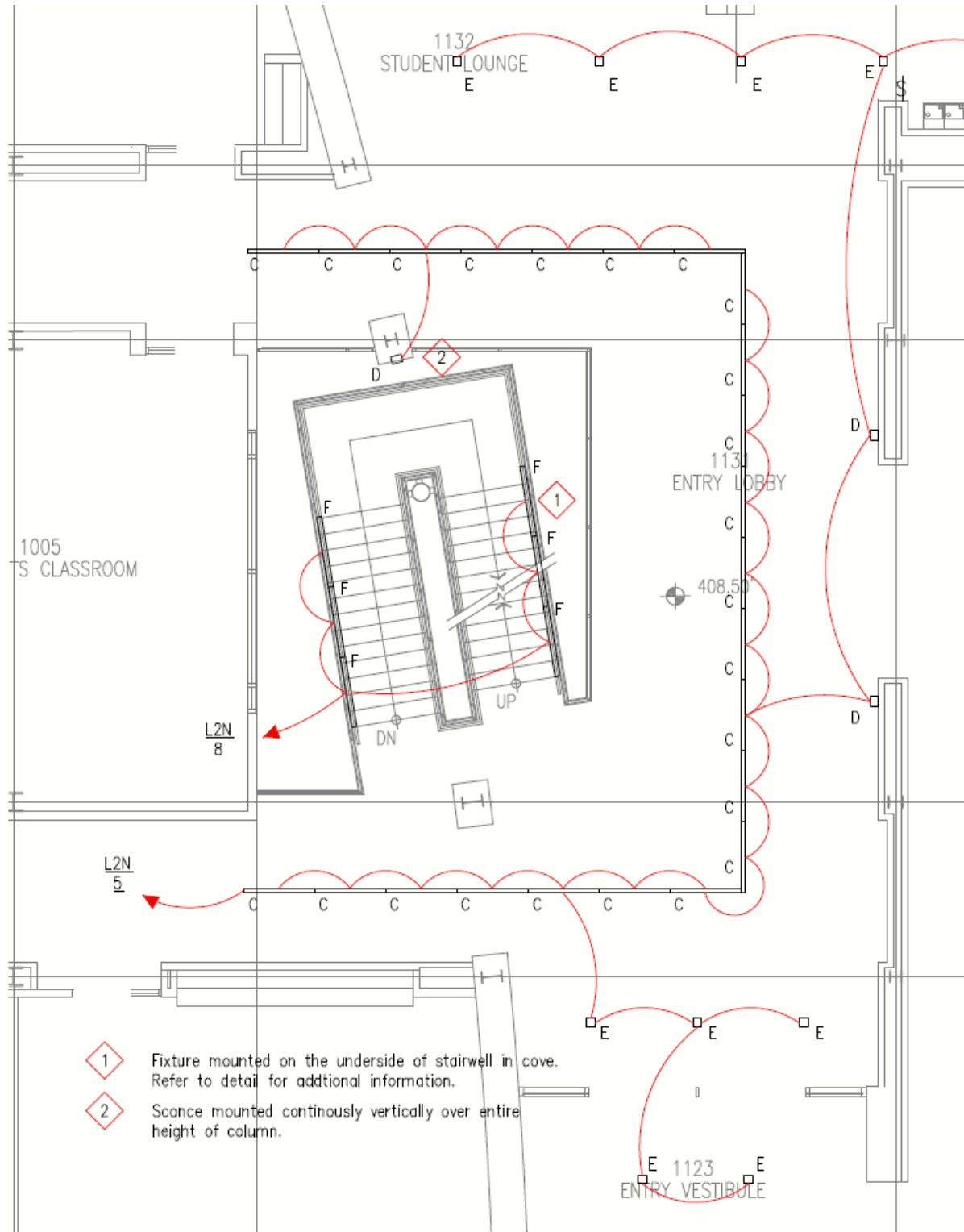

## Appendix I Typical Painting Studio

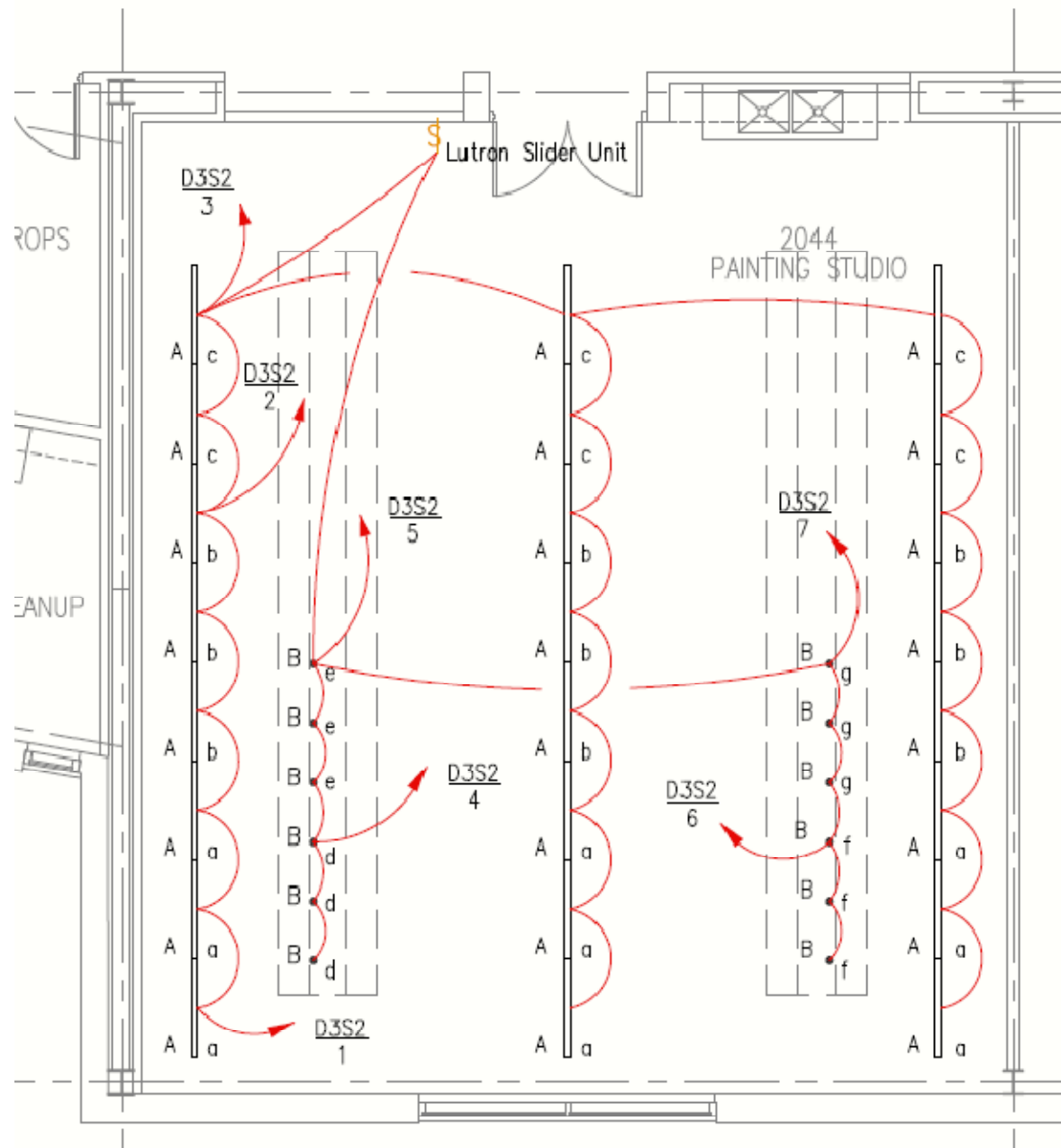

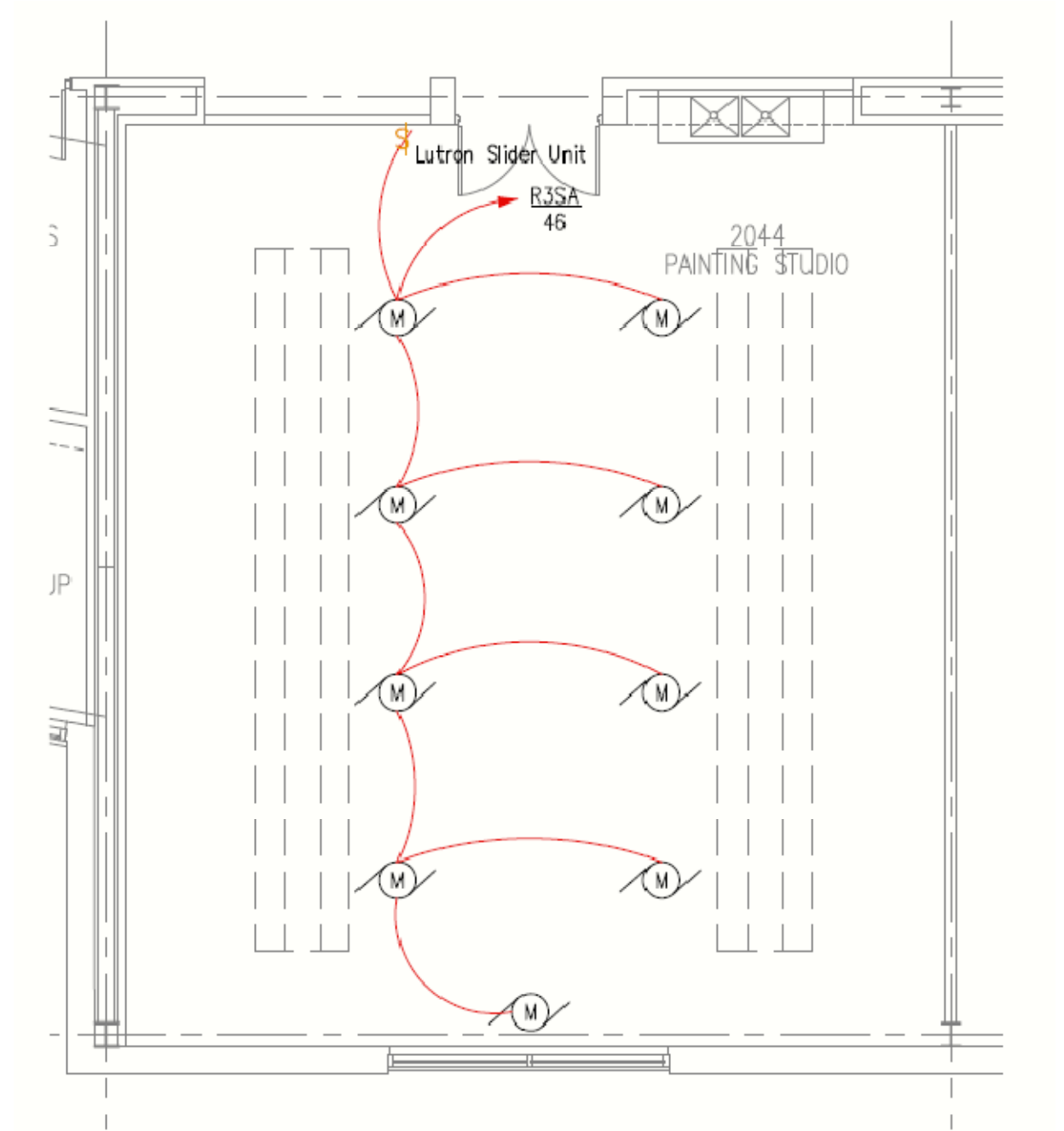

## Appendix J Typical Painting Studio

